

Table of Contents

1. Introduction.....	5
1.1. Minimum System Requirements	6
1.2. Box Content	7
1.3. Views of the Drive	8
1.4. Cables and Connections	9
1.4.1. Hi-Speed USB 2.0.....	9
1.5. Supported DVD and CD Formats	10
1.5.1. DVD and CD Media Format Definitions	10
2. Connecting Your LaCie Portable DVD±RW Drive	11
2.1. Installing DVD/CD Burning Software.....	12
2.2. Connecting the USB 2.0 Cable	13
2.3. Connecting the USB Power Sharing Cable (Optional)	14
3. Using Your LaCie Portable DVD±RW Drive	15
3.1. Inserting Discs	15
3.2. Accessing Discs	15
3.3. Ejecting Discs	16
3.4. Emergency Disc Ejection.....	16
4. Helpful Technical Information	17
4.1. File System Formats.....	17
4.2. DVD±RW Writing Methods.....	18
4.3. About DVD/CD Available Capacity	19
4.4. USB Questions & Answers	19
4.5. Data Transfers	19
5. Troubleshooting	20
5.1. Mac Users.....	21
5.2. Windows Users	23
6. Contacting Customer Support	26
6.1. LaCie Technical Support Contacts	27
7. Warranty Information	28

Copyrights

Copyright © 2011 LaCie. All rights reserved. No part of this publication may be reproduced, stored in a retrieval system, or transmitted in any form or by any means, electronic, mechanical, photocopying, recording or otherwise, without the prior written consent of LaCie.

Trademarks

Apple, Mac, and Macintosh are registered trademarks of Apple Inc. Microsoft, Windows, Windows XP and Windows Vista are registered trademarks of Microsoft Corporation. All trademarks mentioned in this manual are the property of their respective owners.

Changes

The material in this document is for information only and is subject to change without notice. While reasonable efforts have been made in the preparation of this document to assure its accuracy, LaCie assumes no liability resulting from errors or omissions in this document, or from the use of the information contained herein. LaCie reserves the right to make changes or revisions in the product design or the product manual without reservation and without obligation to notify any person of such revisions and changes.

Canada Compliance Statement

This Class A digital apparatus meets all requirements of the Canadian Interference-Causing Equipment Regulations.

Federal Communications Commission Radio Frequency Interference Statement (FCC)



WARNING: Changes or modifications to this unit not expressly approved by the party responsible for compliance could void the user's authority to operate the equipment.

This equipment has been tested and found to comply with the limits for a Class B digital device, pursuant to Part 15 of the FCC Rules. These limits are designed to provide reasonable protection against harmful interference when the equipment is operated in a commercial environment. This equipment generates, uses, and can radiate radio frequency energy, and if not installed and used in accordance with the instructions, may cause harmful interference to radio communications. However, there is no guarantee that interference will not occur in a particular installation. If this equipment does cause harmful interference to radio or television reception, which can be determined by turning the equipment off and on, the user is encouraged to correct the interference by one of the following measures:

- ◆ Reorient or relocate the receiving antennas.
- ◆ Increase the separation between the equipment and the receiver.
- ◆ Connect the equipment into an outlet on a circuit different from that to which the receiver is connected.

- ◆ Consult the reseller or an experienced radio/TV technician for help.

Shielded cables and I/O cards must be used for this equipment to comply with the relevant FCC regulations.

This device complies with Part 15 of the FCC rules. Operation is subject to the following two conditions: (1) this device may not cause harmful interference, and (2) this device must accept any interference received, including interference that may cause undesired operation.

CE Manufacturer's Declaration for CE Certification

We hereby certify that this device is in compliance with both the EMC Directive (2006/95/EC) and the Low Voltage Directive (2004/108/EC) issued by the Commission of the European Community.

Compliance with these directives implies conformity to the following European Norms:

Class B EN60950, EN55022, EN50082-1, EN61000-3-2

Class I Laser product

This equipment is certified to comply with DHHS Rule 21 CFR Chapter I, subchapter J in effect as of the date of manufacture.

This equipment is classified as a Class I Laser product and no hazardous laser radiation is emitted outside the drive.



This symbol on the product or on its packaging indicates that this product must not be disposed of with your other household waste. Instead, it is your responsibility to dispose of your waste equipment by handing it over to a designed collection point for the recycling of waste electrical and electronic equipment. The separate collection and recycling of your waste equipment at the time of disposal will help to conserve natural resources and ensure that it is recycled in a manner that protects human health and the environment. For more information about where you can drop off your waste equipment for recycling, please contact your local city office, your household waste disposal service, or the shop where you purchased the product.

CAUTION: Modifications not authorized by the manufacturer may void the user's authority to operate this device.

Health, Safety & General Use Precautions

The drive you have just purchased includes a laser diode device, which classifies it as a "Laser Class I" product. This laser is not dangerous for the user under normal operating conditions. However, we strongly advise you not to place any reflective objects in the disc loading system, due to the risk of exposure to laser emissions that may be reflected by such objects. Always follow the basic precautions listed below to use your LaCie drive safely and correctly. Respecting these guidelines will help to avoid the possibility of personal injury to yourself or others, as well as to prevent damage to your device and other computer equipment. These include, but are not limited to, the following precautions.

Health & Safety Precautions

- ◆ Read this User Manual carefully, and follow the correct procedure when setting up the device.
- ◆ Do not look inside or place your hand over the open media tray. Never look directly or indirectly (with a mirror) at the laser diode, even when the device is not in operation. If you expose your eyes to the laser inside you drive, you risk damage or loss of your vision or other injury.
- ◆ Do not open your drive or attempt to disassemble or modify it. Never insert any metallic object into the drive to avoid any risk of electrical shock, fire, short-circuiting or dangerous emissions. Your drive contains no user-serviceable parts. If it appears to be malfunctioning, have it inspected by qualified LaCie service staff.
- ◆ Never expose your device to rain or use it near water or in damp or wet conditions. Never place containers on it containing liquids that may spill into its openings. Doing so increases the risk of electrical shock, short-circuiting, fire or personal injury.
- ◆ Make sure that the computer and drive are electrically grounded. If the devices are not grounded, there is an increased risk of electrical shock.

General Use Precautions

- ◆ Do not expose the drive to temperatures outside the range of 5° C to 40° C (41° F to 104° F) during operation. Doing so may damage the drive or disfigure its casing. Avoid placing your drive near a source of heat or exposing it to sunlight (even through a window). Inversely, placing your drive in an environment that is too cold or humid may damage the unit.
- ◆ Do not block the ventilation outlets on the rear of the drive. These help to keep your drive cool during

operation. Blocking the ventilation outlets may cause damage to your drive and cause an increased risk of short-circuiting or fire.

- ◆ Always unplug the drive if there is a risk of lightning or if it will not be used for an extended period of time. Otherwise, there is an increased risk of electrical shock, short-circuiting or fire.
- ◆ Do not place heavy objects on top of the drive or use excessive force on its buttons, connectors and tray.
- ◆ Always place your drive in a horizontal position before using it. This LaCie drive has not been designed to be used in an upright position. This may result in damage to the device or data loss.
- ◆ Always remove the disc from the disc tray before transporting your drive. Otherwise, written data may be destroyed or the drive's internal components may be damaged.
- ◆ Never use excessive force on the disc loading system; discs should be inserted effortlessly into your drive. If you detect a problem, consult the Troubleshooting section and contact your after-sales department.
- ◆ Protect your drive from excessive exposure to dust during use or storage. Dust can build up inside the device, increasing the risk of damage or malfunction.
- ◆ Never use benzene, paint thinners, detergent or other chemical products to clean the outside of the drive. Such products will disfigure and discolor the front panel and casing. Instead, use a soft, dry cloth to wipe the device.

IMPORTANT INFO: Any loss, corruption or destruction of data while using a LaCie drive is the sole responsibility of the user, and under no circumstances will LaCie be held liable for the recovery or restoration of this data. To help prevent the loss of your data, LaCie highly recommends that you keep TWO copies of

your data; one copy on your external hard drive, for instance, and a second copy either on your internal hard drive, another external hard drive or some other form of removable storage media. LaCie offers a complete line of CD and DVD drives. If you would like more information on backup, please refer to our website.

IMPORTANT INFO: 1GB =
1,000,000,000 bytes. 1TB =
1,000,000,000,000 bytes. Once formatted, the actual available storage capacity varies depending on operating environment (typically 5-10% less).

1. Introduction

Congratulations on the purchase of your new LaCie Portable DVD±RW Drive – your complete DVD and CD creation solution! This drive gives you maximum compatibility with the various DVD and CD formats, reading and writing to all of the popular standards (DVD±RDL, DVD±RW, CD-R, CD-RW).



Double Layer DVD Recording

With the same technology that underpins Hollywood-style DVD-Videos, Double Layer (DL) discs are compatible with most consumer set-top DVD players and computer DVD-ROM drives.

On one DVD+RDL disc, you'll be able to store up to four hours of MPEG-2 video, sixteen hours of VHS quality video or increase the video bit rate for higher quality movies. And with 8.5GB of storage space on a single DL disc, they're ideal for archiving and backup applications, and could even be used as replacement for tape in some instances.

Now you have the tools to make high-impact, professional quality DVD videos, conveniently make system backups and preserve all of your memories for the future.

Quick Links

Click a topic:

- ◆ [Connecting Your LaCie Portable DVD±RW Drive](#)
- ◆ [Using Your LaCie Portable DVD±RW Drive](#)



1.1. Minimum System Requirements

Windows Users

- ◆ USB equipped computer
- ◆ Windows XP or Windows Vista
- ◆ Pentium IV processor or higher
- ◆ 256MB RAM

Mac Users

- ◆ USB equipped computer
- ◆ Mac OS X 10.4
- ◆ Power PC G5 or later, Mac Intel processor
- ◆ 256MB RAM

Linux Users

- ◆ USB equipped computer
 - ◆ Linux-based system
 - ◆ 256MB RAM
-

1.2. Box Content

Your LaCie Portable DVD±RW Drive box should contain the following:

1. LaCie Portable DVD±RW Drive
2. USB 2.0 cable
3. USB power sharing cable
4. Quick Install Guide
5. LaCie DVD Utilities CD-ROM(s)

IMPORTANT INFO: Please save your packaging. In the event that the drive should need to be repaired or serviced, it must be returned in its original packaging.

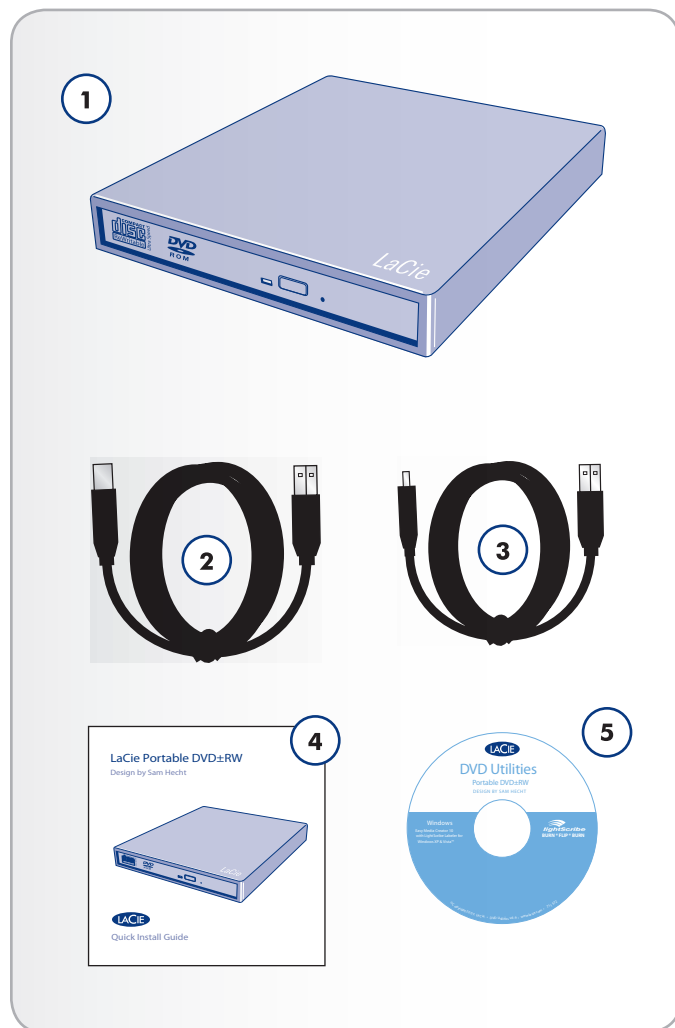

1.3. Views of the Drive

Front View

1. **Disc Tray** – Open the tray by pressing the load/eject button, then place a DVD or CD into the tray with the label facing up. Close the tray by pushing the load/eject button or pushing the front part of the tray. This drive has not been designed to accept media with cartridges.
2. **Drive Activity LED**
3. **Load/Eject Button** – Push this button to open the media tray.
4. **Emergency Eject Hole** – Insert a straightened paper clip (or similar object) and push to eject the tray if the load/eject button does not work. In normal operation, the eject button should always be used to unload the tray. If you must use the emergency eject hole, make sure the drive's power is turned off and wait until disc rotation has stopped.

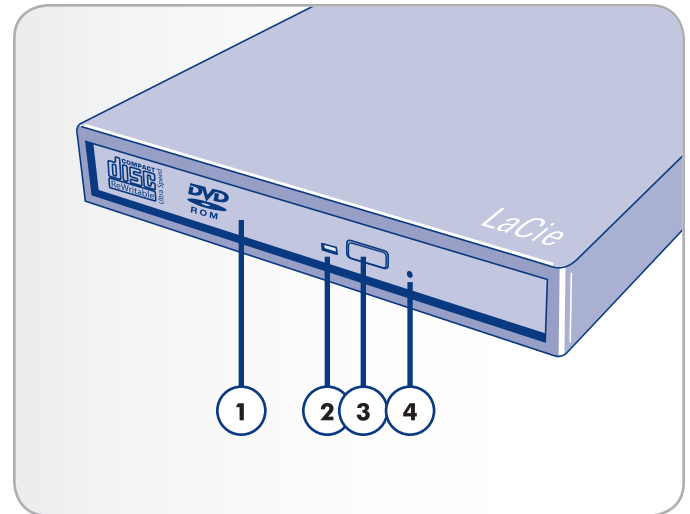

Fig. 01

Rear View

1. **Power Supply Connection** – This is where you plug in the AC adapter supplied with the drive. See section 2.3. [Connecting the USB Power Sharing Cable \(Optional\)](#) for more information.
2. **Hi-Speed USB 2.0 Port** – This is where you plug in the USB 2.0 cable supplied with the drive. See section 2.2. [Connecting the USB 2.0 Cable](#) for more information.

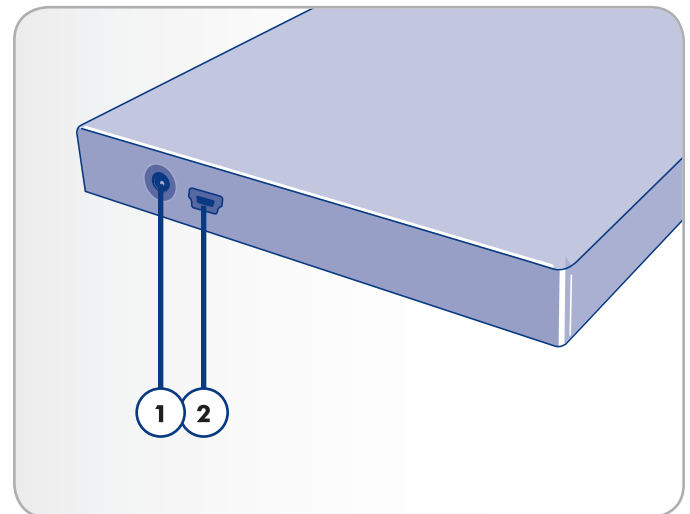

Fig. 02

1.4. Cables and Connections

1.4.1. Hi-Speed USB 2.0

USB is a serial input/output technology for connecting peripheral devices to a computer or to each other. Hi-Speed USB 2.0 is the latest implementation of this standard, and it provides the necessary bandwidth and data transfer rates to support high speed devices such as hard drives, CD/DVD drives and digital cameras.

USB 2.0 Cables

Your LaCie drive is shipped with a Hi-Speed USB 2.0 cable to ensure maximum data transfer performance when connected to a Hi-Speed USB 2.0 port. The cable will also work when connected to a USB 1.1 port, but drive performance will be limited to USB 1.1 transfer rates.

USB Icons

These icons will help you easily identify the USB interfaces. They appear on USB cables and next to the USB port connectors on certain computers.

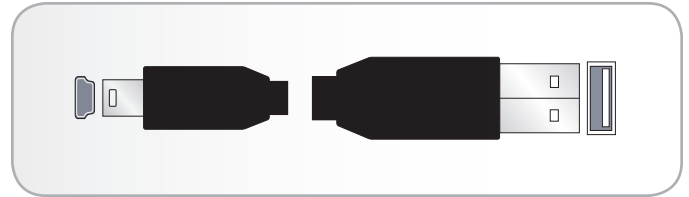

Fig. 03 - USB Cable Ends



Fig. 04 - USB 2.0 logo



Fig. 05 - USB 1.0 logo

1.5. Supported DVD and CD Formats

Table 01 - Supported DVD and CD Formats

Format	Type of Disc	Write Speed	Capacity
DVD	DVD±R DL	4x	8.5GB
	DVD±R	8x	4.7GB
	DVD+RW	8x	4.7GB
	DVD-RW	6x	4.7GB
	DVD-ROM (Single and dual layer)	--	4.7/8.5 GB
	DVD-RAM	5x	4.7/8.5GB
CD	CD-R	32x	700MB
	CD-RW	24x	650MB
	CD-ROM	--	--

1.5.1. DVD and CD Media Format Definitions

DVD+RW Discs

- ◆ Best suited for: backing up and archiving digital content.
- ◆ These discs are functionally similar to CD-RW and DVD-RW discs, but utilizes the same recording techniques as DVD+R. Incorporates the Direct Overwrite (DOW) system, allowing data to be written directly over existing data in a single pass.

DVD-RW Discs

- ◆ Best suited for: backing up and archiving digital content.
- ◆ These discs serve the same general purpose as CDRW media, but with 4.7GB of space versus 650MB.
- ◆ Discs can be written and erased up to 1,000 times.

DVD+R Discs

- ◆ Best suited for: recording DVD videos, storing multiple photo albums and data DVDs under 4.7GB.
- ◆ These discs have the same write-once concept as CDR media, but with 4.7GB of capacity versus 700MB for CD-R discs.
- ◆ DVD+R supports “lossless linking” and the combination of Constant Angular Velocity (CAV) and Constant Linear Velocity (CLV) recording techniques.

DVD-R Discs

- ◆ Best suited for: recording DVD videos, storing multiple photo albums and data DVDs under 4.7GB.
- ◆ These discs are also functionally similar to CD-R media, and

have the same capacity as DVD+R discs.

- ◆ There are two types of DVD-R discs: DVD-R General, which are intended for home applications, and DVD-R Authoring, which are intended for professional DVD-Video development applications.

DVD+RDL or DVD-RDL (Double Layer) Discs

- ◆ Ideal for: recording high-quality DVD videos, backing up and archiving large data DVDs.
- ◆ These discs follow the DVD+ recording techniques, but with 8.5GB of capacity versus 4.7GB for DVD±R discs.
- ◆ With the increased capacity, it is now possible to increase the video bit rate for higher quality DVD videos.

DVD-RAM

- ◆ Best suited for camcorders, set-top boxes, and other uses where the ability to erase and rewrite is important.
- ◆ Considered a very reliable format thanks to its built-in error control and defect management system.

CD-R Discs

- ◆ Best suited for: recording audio CDs, storing photos and for data CDs.
- ◆ Files can not be deleted from CD-R discs, and you cannot write over existing files on a CD-R disc.

CD-RW Discs

- ◆ Best suited for: passing medium sized files around an office or among students.
- ◆ Discs can be reformatted up to 1,000 times, and files can be written over.
- ◆ Most CD-ROM drives and audio CD players cannot read CD-RW discs.

TECHNICAL NOTE: For Best Recording Results:

- ◆ Close all other open programs and disconnect from the internet
 - ◆ Copy data to your hard drive first
 - ◆ Check media speed rating
 - ◆ Use media that is free of scratches and fingerprints
-

2. Connecting Your LaCie Portable DVD±RW Drive

There are three parts to connecting and turning on your LaCie Portable DVD±RW Drive.

Step 1	<i>2.1. Installing DVD/CD Burning Software</i>
Step 2	<i>2.2. Connecting the USB 2.0 Cable</i>
Step 3	<i>2.3. Connecting the USB Power Sharing Cable (Optional)</i>

2.1. Installing DVD/CD Burning Software

Installation

1. Insert the LaCie DVD Utilities DVD-ROM and open it when it mounts on your computer.
2. Open the “Easy Media Creator” folder (Windows users) or the “Toast Titanium” folder (Mac users).
3. Double-click the installer and follow the on-screen instructions.

For more information about the various programs, please refer to the software’s Help menu.

About the Bundled Software

IMPORTANT INFO: Available software vary from one model to another. For a complete list of software, please check the packaging of your product or the label of the included DVD-ROM.

- ◆ Toast 9 Basic (Mac)
- ◆ Easy Media Creator 10 (Windows)
- ◆ Lacie LightScribe Labeler (Mac)

LaCie reserves the right to include a higher version of these software or different software. Please check your product packaging for an exact list.

Please see www.roxio.com for information on Toast Basic and Easy Media Creator.

Please check the LaCie website for software updates:

www.lacie.com/support/drivers/dvd

2.2. Connecting the USB 2.0 Cable

1. Connect the Hi-Speed USB 2.0 cable to the USB 2.0 port on the back of the drive.
2. Attach the other end of the USB 2.0 cable to an available USB port on your computer.
3. Your drive should now be ready for use. To verify that your drive is correctly installed and communicating with your computer, follow these steps:

Mac Users

In the Apple menu, click on About This Mac, then More Info. This will open the Apple System Profiler. Your drive should be listed under the Hardware category.

Windows Users

Right click your My Computer folder and select Properties. Click on General. Your drive should be listed.

TECHNICAL NOTE: Your drive must be connected to a USB 2.0 (as opposed to USB 1.1) port. See section [1.4. Cables and Connections](#).

TECHNICAL NOTE: For more information on USB connections, see sections [1.4. Cables and Connections](#) and [4.4. USB Questions & Answers](#).

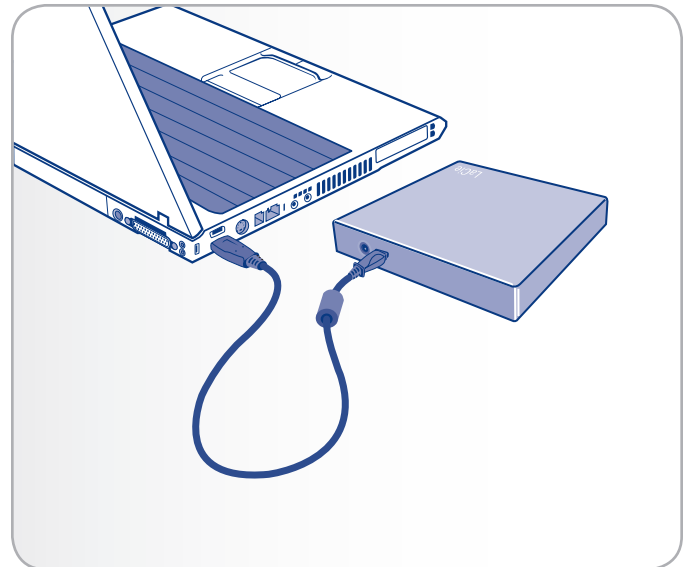

Fig. 06

2.3. Connecting the USB Power Sharing Cable (Optional)

The LaCie Portable DVD±RW USB 2.0 draws power from your computer's USB bus and should not require the use of a power supply. However, if the USB bus does not supply sufficient power to operate the drive, you can connect the USB power sharing cable (included).

1. Connect the USB cable as described in section 2.2. [Connecting the USB 2.0 Cable](#).
2. Connect the large end of the USB power sharing cable to an open USB port on your computer.
3. Connect the other, smaller end of the USB power sharing cable to the back of the LaCie Portable DVD±RW.

NOTE: You can alternatively purchase an external power supply, which connects to a wall outlet, from the LaCie website.

CAUTION: Only use the AC adapter supplied with your specific LaCie drive. Do not use a power supply from another LaCie drive or another manufacturer. Using any other power cable or power supply may cause damage to the device and void your warranty.

CAUTION: Always remove the AC adapter before transporting your LaCie drive. Failure to remove the adapter may result in damage to your drive and will void your warranty. If your power supply gets damaged, a replacement can be purchased from your local LaCie retailer or on the LaCie website.

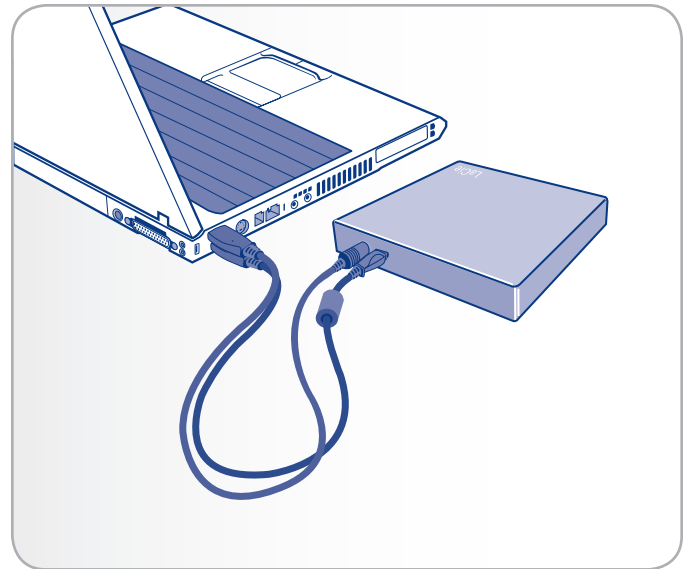

Fig. 07

3. Using Your LaCie Portable DVD±RW Drive

3.1. Inserting Discs

To insert a disc:

1. Push the Open/Close button on your LaCie Portable DVD±RW Drive.
2. When the disc tray opens, put the DVD or CD media into the tray with the label side facing up. Make sure the DVD or CD is correctly placed in the center of the disc tray.
3. Push the Open/Close button to close it (Fig. 08).

Do not attempt to force the door open; you will damage the drive. The power must be on in order to open the drive. The drive must be on a flat surface to work correctly.

To close the disc tray:

Press the Open/Close button (Fig. 08). Pushing the media tray closed is not recommended.



Fig. 08

3.2. Accessing Discs

Mac Users

The DVD or CD volume will appear as an icon on the desktop. Click on the icon to access the contents of the DVD or CD.

Windows Users

The DVD or CD volume will appear in your My Computer folder (Windows XP users) or the Computer folder (Vista users). Click on the icon to access the contents of the disc.

CAUTION: Do not force the disc tray open or closed, as you will damage the drive. Also always remove discs before transporting the drive, and never move the drive while it is in operation.

IMPORTANT INFO: This drive is not compatible with cartridges.

3.3. Ejecting Discs

Mac Users

1. Drag the DVD/CD icon on the desktop to the Trash (Fig. 09).
2. The disc tray will open.
3. Remove the disc.

Push the Open/Close button on the drive to close the disc tray.

Windows Users

1. Press the Open/Close button on the front of the drive.
2. Remove the disc.
3. Push the Open/Close button on the drive to close the disc tray.

CAUTION: Do not attempt to open the drive's disc tray or remove the disc while the unit is in use and being accessed by the computer. You may injure yourself and/or damage the drive and/or your computer system. Do not transport the drive with the disc tray open or with a DVD or CD disc inside. Doing so may damage the drive and/or data stored on the disc, and will void your warranty.

3.4. Emergency Disc Ejection

In the event that a DVD or CD cannot be ejected with the Open/Close button and the software is not controlling the drive, use the emergency eject operation to open the disc tray.

1. Switch off the drive and unplug the interface cable.
2. Insert a small metal poker, such as an unbent paper clip, into the emergency eject hole (see Fig. 10) until the poker presses against the manual eject mechanism. You will feel the mechanism eject the disc tray.

Only use this method if the Open/Close button is not working.

CAUTION: Make sure the drive is off and the power unplugged before attempting the emergency ejection procedure.

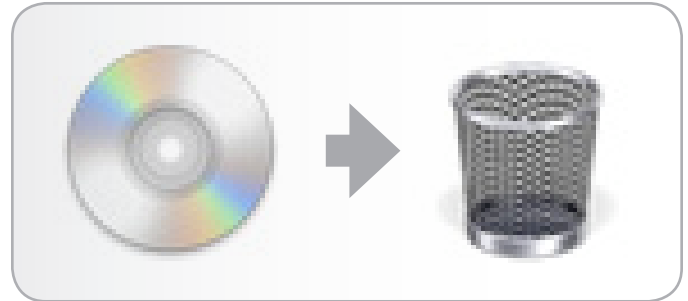

Fig. 09



Fig. 10

4. Helpful Technical Information

4.1. File System Formats

When writing DVD±R/RW and CD-R/RW discs, you will have the option to assign the disc a particular file format (the way in which a computer names and organizes files for storage and to manage data exchange).

There are essentially three file system formats to be concerned with when using a LaCie DVD/CD Drive:

- ◆ Universal Disk Format (UDF)
- ◆ ISO 9660
- ◆ Mac OS Extended (also known as HFS+)
- ◆ Hybrid discs (Mac & PC)

UDF – This specification, developed by Optical Storage Technologies Association, is the predominant file system that allows compatibility across various Bluray, DVD and CD applications, hardware platforms and computer operating systems.

ISO 9660 – This is the standard file system which allows media to be read on a Mac, PC or other major computer platform. Published by the International Organization of Standardization, this standard defines a file system for DVD-ROM and CDs. It supports Microsoft Windows, Mac OS and operating systems that follow the Unix specification, but doesn't support custom features of Mac file systems such as long file names or icon options. Microsoft created an extension to the format, called Joliet, which allows for Unicode file character names and file names up to 64 characters in length (twice as many as the ISO 9660 Level 2 and 3 specifications).

Mac OS Extended – Also known as HFS+, this is the file system used by Macintosh. If you will be using your disc only on Macs, this is the preferred file format.

Hybrid discs (Mac & PC) – Mac users can also choose to create hybrid discs which contain two partitions: one to be viewed by Mac users, one by Windows users. Toast Titanium does allow this file system choice.

4.2. DVD±RW Writing Methods

Disc at Once (DAO) – A DVD writing process in which the entire DVD is recorded in one session, and data cannot be added after the recording is finished. Differs from the CD-R DAO method because the lead-in, data area and lead-out areas are all written sequentially.

Session at Once (SAO) – A writing process which is similar to DAO, where all of the information is written in one session, but SAO allows for the ability to begin another session and record at a later time. This mode allows for greater control of the recording process than

Packet Writing (PW) or **TAO**, and more disc space can be utilized because there is no need for gaps between tracks.

Incremental Recording (IR) – A writing process that is similar to the Session at Once (SAO) CDR writing method; files may be added directly to the DVD-R disc one recording at a time, instead of recording the files to a hard drive before writing the disc. The minimum recorded size, though, must be at least 32KB (even if the file to be recorded is smaller than that), and capacities and write speeds are decreased due to the overhead of combined lead-in/out areas and data. Also, the disc must be finalized before it may be played back by a drive other than the drive recording the disc.

Multi-Border Recording (MBR) – A writing process that is very similar to IR, MBR allows you to make an IR disc and then play the disc back on a device that recognizes this type of recording method. MBR creates a very short boundary zone around a recording session so a compatible player or DVD-ROM drive does not attempt to play beyond the border of the recorded area, instead allowing the unfinalized disc to be read by a player that supports this recording method.

Restricted Overwriting (RO) – With this method, if a disc has already been written to, new data segments can be randomly inserted anywhere within the recorded boundary. New data, however, can only be added to an area of the disc that has already been recorded over and from the point where the last session was stopped.

Packet Writing (PW) – A drag-and-drop writing process writing process that is very useful for data backup. Buffer underrun* is impossible in this mode, because the data is written in “packets” of a few KBs. Packet Writing is a CPU-intensive process because it constantly checks the available space on the disc.

Table 02 - DVD±RW Writing Methods

	DAO	SAO	IR	MBR	RO	PW
CD	✓	✓				✓
DVD	✓		✓	✓	✓	

* Buffer Underrun – The recording of a disc is a system-intensive application, and the rewritable drive needs a constant stream of data. A buffer underrun occurs when the stream of data to the rewritable drive is not fast enough to keep the rewritable drive’s buffer full, causing the an error in the recording process. If this problem occurs often, turn down the recording speed.

4.3. About DVD/CD Available Capacity

There are important factors to consider when recording video, audio or data to CD or DVD discs. The DVD media specification provides for two physical sizes: 4.7" (12cm) and 3.1" (8cm) (both are .47" (1.2cm) thick). DVD discs are single-sided and can have one (SL) or two (DL) layers of data.

The amount of data or video that a disc can hold are dependent upon factors such as the amount of audio and the degree of compression of the data, video or audio.

When media companies reference the amount of data that a disc can hold, they represent the total amount in terms of gigabytes (GB), or a billion bytes (1000 x 1000 x 1000 bytes). This number, though, is not the way in which a computer addresses the data; to a computer the value is binary and larger than a billion bytes – 1,073,741,824 (1024 x 1024 x 1024 bytes).

4.4. USB Questions & Answers

What Are the Benefits of the USB Interfaces?

- ◆ Cross-platform: All recent Macintoshes and PC include USB ports.
- ◆ "Hot Swappable": No need to shut down or restart your computer when adding or removing a USB device. Plug it in and its ready.
- ◆ Automatic configuration: Once your device is connected, your computer recognizes the device and configures the software (Windows 2000, Windows XP and Windows Vista).
- ◆ Daisy-Chaining: with USB ports on your computer, you can connect up to 127 peripherals using hubs.
- ◆ Easy Installation: One standardized port and plug combination makes it simple to connect.

Will Hi-Speed USB 2.0 Devices Work on USB 1.1 Hubs and Vice Versa?

You can use your Hi-Speed USB 2.0 devices with USB 1.1 hubs, but the peripherals will be limited to USB 1.1 performance levels.

For more information about the USB interface, please visit the LaCie website:

www.lacie.com/technologies

4.5. Data Transfers

Data transfers are the flow of data that accomplishes a task, usually related to moving data from storage to computer RAM or between storage devices. During data transfers, it's best to wait before launching other applications on the same USB port. Anomalies may arise with computers that have USB controllers that do not conform to OHCI (Open Host Controller Interface*) standards. In any other configurations, we cannot ensure 100% correct operation. Due to this, you may encounter hanging problems. If this happens, proceed as follows:

1. Make sure that the USB cable is connected tightly and securely on both ends of the cable, from the drive to the computer. If you are using a USB cable other than the one supplied with your LaCie drive, check that it is Hi-Speed USB 2.0 certified.
2. Check that the power supply and ground connection are seated properly.
3. Disconnect your computer's USB cable. Wait 30 seconds. Reconnect.

TECHNICAL NOTE: *Controller - This is a component or an electronic card (referred to in this case as a "controller card") that enables a computer to communicate with or manage certain peripherals. An external controller is an expansion card which fills one of the free slots (i.e. PCI or PCMCIA) inside your PC and which enables a peripheral (i.e. DVD/RW drive, Hard Drive, scanner or printer) to be connected to the computer. If your computer is not equipped with a USB controller card, you can purchase an external controller through LaCie. Contact your LaCie reseller or LaCie Technical Support (section 6. [Contacting Customer Support](#)) for more information.

5. Troubleshooting

In the event that your LaCie Portable DVD±RW Drive is not working correctly, please refer to the following checklist to determine the source of the problem. If you have gone through all of the points on the checklist and your drive is still not working correctly, please check the FAQs that are regularly published on our Web site, www.lacie.com. One of these FAQs may provide an answer to your specific question. You can also visit the downloads page, where the most recent software updates will be available.

If you need further assistance, please contact your LaCie reseller or LaCie Technical Support (see section 6. *Contacting Customer Support* for details).

Manual Updates

LaCie is constantly striving to give you the most up-to-date, comprehensive User's Manuals available on the market. It is our goal to provide you with a friendly, easy-to-use format that will help you quickly install and utilize the many functions of your new device.

If your manual does not reflect the configurations of the product that you purchased, please check our Web site for the most current version available.

The Troubleshooting tips on the following pages are divided up by operating system.

5.1. Mac Users

Problem	Question	Solution
The drive is not recognized by the computer.	Does your computer's configuration meet the minimum system requirements for use with this drive?	See section 1.1. Minimum System Requirements .
	Is the drive receiving enough power through your computer's USB bus?	If your drive doesn't mount on your computer, it is possible that it is not receiving enough power through your computer's USB bus. For information on connecting the optional USB power sharing cable, see 2.2. Connecting the USB 2.0 Cable .
	Did you follow the correct installation steps?	Review the installation steps in 2.3. Connecting the USB Power Sharing Cable (Optional) .
	Is there an icon for the drive in My Computer?	Go into My Computer and look for an icon and drive letter assigned to the LaCie drive. If the drive does not appear, follow the rest of the Troubleshooting tips to isolate the problem.
	Are both ends of the USB cable securely attached?	<ul style="list-style-type: none"> ◆ Disconnect the USB cable, wait 10 seconds and then reconnect. ◆ Ensure that USB connectors are properly aligned. USB cables can only be inserted one way. Make sure that they are correctly oriented. ◆ Check that the USB connectors are straight and fully seated in the USB ports. ◆ Only use certified USB cables, such as the cables provided with your LaCie drive. <p>If you have followed all of these steps and the drive is still not recognized, shut down your computer, wait 3 to 5 minutes, restart your computer and try again.</p>
	Is there a conflict with other device drivers or extensions?	Contact LaCie Customer Support for assistance. See 6.1. LaCie Technical Support Contacts .
The drive is not running noticeably faster when connected via Hi-Speed USB 2.0.	Are there other USB devices connected to the same port or hub?	Disconnect any other USB devices and see if the drive's performance improves.
	Is the drive connected to a USB hub?	A Hi-Speed USB 2.0 device can only operate at Hi-Speed USB 2.0 speeds if it is connected to a Hi-Speed USB 2.0 port or hub. Make sure your USB hub supports Hi-Speed USB 2.0.
	Is the drive connected to a Hi-Speed USB 2.0 port on your computer?	Make sure that the Hi-Speed USB 2.0 drivers for both your host bus adapter and device have been installed correctly. If in doubt, uninstall the drivers and re-install them.
	Does your computer or operating system support Hi-Speed USB 2.0?	See 1.1. Minimum System Requirements and 4.5. Data Transfers for more information.
The drive is working slowly.	Is the drive connected directly to the host computer?	Make sure that your drive is connected directly to the computer (see 2.3. Connecting the USB Power Sharing Cable (Optional) for more information). For best performance, connect devices directly to the computer. For more information, see 4.5. Data Transfers .

Problem	Question	Solution
The drive's media tray will not open.	Have you tried dragging the disc's icon to the Trash?	Drag the disc icon onto the Trash icon. The disc should then eject automatically. If this does not work, try using the eject function of the software program that you are using.
	Has a running software program locked the eject function?	To check, disconnect the interface cable, then reconnect and push the Open/Close button. If the disc still will not eject, see section 3.4. Emergency Disc Ejection for more information on how to eject your media.
The drive's media tray automatically ejects a disc when you try to record on it, or the drive is not writing to CD/DVD correctly.	Is the disc full?	To verify the contents of the disc: <ul style="list-style-type: none"> ◆ Use your recording software OR ◆ Select the disc on the desktop and select Get Info from the File menu. If the disc appears empty but the problem persists, try using another piece of media.
	Does the drive support the format of the disc you have inserted?	Check section 1.5. Supported DVD and CD Formats for information about the different formats supported by your drive.
	Is the disc damaged?	Carefully inspect the disc. Look to see if there are highly visible scratches to the recording surface (the bright, shiny, reflective side) of the disc. If in doubt, try another disc.
	Has the recording software been installed correctly?	Double-check the installation of your recording software and re-install the software, if necessary. Review the recording software's troubleshooting and help sections for more information about the recording software.
	Has buffer underrun occurred (has something interrupted the stream of data to the recorder)?	For the best recordings, follow these tips to avoid buffer underrun interruptions: <ul style="list-style-type: none"> ◆ Quit all other running software programs before starting to record. ◆ De-activate File Sharing if it is active. ◆ If you are making a direct recording, such as a copy, from a CD or a DVD, make sure that the speed of the drive playing the CD or DVD is fast enough to provide a sufficient data stream to the LaCie drive. When making copies, it is recommended that you transfer the material to be copied to your hard drive, and then make the recording from the data on the hard drive. ◆ Reduce the write speed of the LaCie drive using the appropriate menu in the recording software.

5.2. Windows Users

Problem	Question	Solution
The drive is not recognized by the computer.	Does your computer's configuration meet the minimum system requirements for use with this drive?	See section 1.1. Minimum System Requirements .
	Is the drive receiving enough power through your computer's USB bus?	If your drive doesn't mount on your computer, it is possible that it is not receiving enough power through your computer's USB bus. For information on connecting the optional USB power sharing cable, see 2.2. Connecting the USB 2.0 Cable .
	Did you follow the correct installation steps?	Review the installation steps in 2. Connecting Your LaCie Portable DVD±RW Drive .
	Is there an icon for the drive in My Computer?	Go into My Computer and look for an icon and drive letter assigned to the LaCie drive. If the drive does not appear, follow the rest of the Troubleshooting tips to isolate the problem.
	Are both ends of the USB cable securely attached?	<ul style="list-style-type: none"> ◆ Disconnect the USB cable, wait 10 seconds and then reconnect. ◆ Ensure that USB connectors are properly aligned. USB cables can only be inserted one way. Make sure that they are correctly oriented. ◆ Check that the USB connectors are straight and fully seated in the USB ports. ◆ Only use certified USB cables, such as the cables provided with your LaCie drive. <p>If you have followed all of these steps and the drive is still not recognized, shut down your computer, wait 3 to 5 minutes, restart your computer and try again.</p>
	Is there a conflict with other device drivers or extensions?	Contact LaCie Customer Support for assistance. See 6.1. LaCie Technical Support Contacts .
	Have the USB drivers been installed correctly and enabled?	<p>Windows 2000 Users:</p> <p>Go to Start > Settings > Control Panel > System > Hardware tab > Device Manager button > USB Controller. Click on the + sign next to the controller icon, and you should see your device listed.</p> <p>Windows XP and Windows Vista Users:</p> <p>Go to Start > Control Panel > Performance and Maintenance > System > Hardware tab > Device Manager button > USB Controller. Click on the + sign next to the controller icon, and you should see your device listed.</p> <p>If you still can't see your device, recheck the cables and try the other troubleshooting tips listed here.</p>

Problem	Question	Solution
The drive is not running noticeably faster when connected via Hi-Speed USB 2.0.	Are there other USB devices connected to the same port or hub?	Disconnect any other USB devices and see if the drive's performance improves.
	Is the drive connected to a USB hub?	A Hi-Speed USB 2.0 device can only operate at Hi-Speed USB 2.0 speeds if it is connected to a Hi-Speed USB 2.0 port or hub. Make sure your USB hub supports Hi-Speed USB 2.0.
	Is the drive connected to a Hi-Speed USB 2.0 port on your computer?	Make sure that the Hi-Speed USB 2.0 drivers for both your host bus adapter and device have been installed correctly. If in doubt, uninstall the drivers and re-install them.
	Does your computer or operating system support Hi-Speed USB 2.0?	See 1.1. Minimum System Requirements and 4.5. Data Transfers for more information.
The drive is working slowly.	Is the drive connected directly to the host computer?	Make sure that your drive is connected directly to the computer (see 2.3. Connecting the USB Power Sharing Cable (Optional) for more information). For best performance, connect devices directly to the computer. For more information, see 4.5. Data Transfers .
DVD-Video playback does not work.	Have you installed the appropriate MPEG-2 software decoder?	Ensure that the MPEG-2 software has been installed correctly. See the help section of the software program for more information.
	Has the LaCie drive been set as the default DVD drive in your DVD playback software?	Consult the Help section of your DVD playback software for information on how to configure your LaCie drive as your default DVD player.
	Are you running other software programs simultaneously?	Check to see if other programs are running. If so, close them. Depending on your computer's configuration, playback may be possible only if the DVD player software is the only program running.
The drive's media tray automatically ejects a disc when you try to record on it, or the drive is not writing to CD/DVD correctly.	Is the disc full?	To verify the contents of the disc: <ul style="list-style-type: none"> ◆ Use your recording software OR ◆ Select the disc on the desktop and select Get Info from the File menu. If the disc appears empty but the problem persists, try using another piece of media.
	Does the drive support the format of the disc you have inserted?	Check section 1.5. Supported DVD and CD Formats for information about the different formats supported by your drive.
	Is the disc damaged?	Carefully inspect the disc. Look to see if there are highly visible scratches to the recording surface (the bright, shiny, reflective side) of the disc. If in doubt, try another disc.
	Has the recording software been installed correctly?	Double-check the installation of your recording software and re-install the software, if necessary. Review the recording software's troubleshooting and help sections for more information about the recording software.

Problem	Question	Solution
<p>The drive's media tray automatically ejects a disc when you try to record on it, or the drive is not writing to CD/DVD correctly.</p>	<p>Has buffer underrun occurred (has something interrupted the stream of data to the recorder)?</p>	<p>For the best recordings, follow these tips to avoid buffer underrun interruptions:</p> <ul style="list-style-type: none">◆ Quit all other running software programs before starting to record.◆ De-activate File Sharing if it is active.◆ If you are making a direct recording, such as a copy, from a CD or a DVD, make sure that the speed of the drive playing the CD or DVD is fast enough to provide a sufficient data stream to the LaCie drive. When making copies, it is recommended that you transfer the material to be copied to your hard drive, and then make the recording from the data on the hard drive.◆ Reduce the write speed of the LaCie drive using the appropriate menu in the recording software.

6. Contacting Customer Support

Before You Contact Technical Support

1. Read the manuals and review section [5. Troubleshooting](#).
2. Try to isolate the problem. If possible, make the drive the only external device on the CPU, and make sure that all of the cables are correctly and securely attached.

If you have asked yourself all of the pertinent questions in the troubleshooting checklist, and you still can't get your LaCie drive to work properly, contact us at www.lacie.com. Before contacting us, make sure that you are in front of your computer and that you have the following information on hand:

Information	Where to Find Information
LaCie Portable DVD±RW Drive serial number	Located on a sticker at the back of drive or on the original packaging
Macintosh/PC model	<p>Mac users: Click on the Apple icon in the menu bar and select About This Mac.</p> <p>Windows users: Right click My Computer and select Properties > General.</p>
Operating system version	
Processor speed	
Computer memory	
The brands and models of other internal and external peripherals installed on your computer	<p>Mac users: Click on the Apple icon in the finder bar and select About This Mac. Select More Info... The Apple System Profiler will launch and will list your internal and external peripherals.</p> <p>Windows users: Right click My Computer and select Properties > Hardware.</p>

6.1. LaCie Technical Support Contacts

LaCie Asia, Singapore, and Hong Kong Contact us at: http://www.lacie.com/asia/contact/	LaCie Australia Contact us at: http://www.lacie.com/au/contact/
LaCie Belgium Contact us at: http://www.lacie.com/be/contact/ (Français)	LaCie Canada Contact us at: http://www.lacie.com/caen/contact/ (English)
LaCie Denmark Contact us at: http://www.lacie.com/dk/contact	LaCie Finland Contact us at: http://www.lacie.com/fi/contact/
LaCie France Contact us at: http://www.lacie.com/fr/contact/	LaCie Germany Contact us at: http://www.lacie.com/de/contact/
LaCie Italy Contact us at: http://www.lacie.com/it/contact/	LaCie Japan Contact us at: http://www.lacie.com/jp/contact/
LaCie Netherlands Contact us at: http://www.lacie.com/nl/contact/	LaCie Norway Contact us at: http://www.lacie.com/no/contact/
LaCie Spain Contact us at: http://www.lacie.com/es/contact/	LaCie Sweden Contact us at: http://www.lacie.com/se/contact
LaCie Switzerland Contact us at: http://www.lacie.com/chfr/contact/ (Français)	LaCie United Kingdom Contact us at: http://www.lacie.com/uk/contact/
LaCie Ireland Contact us at: http://www.lacie.com/ie/contact/	LaCie USA Contact us at: http://www.lacie.com/contact/
LaCie International Contact us at: http://www.lacie.com/intl/contact/	

7. Warranty Information

LaCie warrants your drive against any defect in material and workmanship, under normal use, for the period designated on your warranty certificate. In the event this product is found to be defective within the warranty period, LaCie will, at its option, repair or replace the defective drive.

This warranty is void if:

- ◆ The drive was operated/stored in abnormal use or maintenance conditions;
- ◆ The drive is repaired, modified or altered, unless such repair, modification or alteration is expressly authorized in writing by LaCie;
- ◆ The drive was subjected to abuse, neglect, lightning strike, electrical fault, improper packaging or accident;
- ◆ The drive was installed improperly;
- ◆ The serial number of the drive is defaced or missing;
- ◆ The broken part is a replacement part such as a pickup tray, etc.
- ◆ The tamper seal on the drive casing is broken.

LaCie and its suppliers accept no liability for any loss of data during the use of this device, or for any of the problems caused as a result. As a precaution, it is recommended that the CD-R/RW, DVD-R/RW and DVD+R/RW media be tested after they have been written to. Under no circumstances do LaCie or its suppliers guarantee the reliability of the DVD or CD media used in this drive.

LaCie will not, under any circumstances, be liable for direct, special or consequential damages such as, but not limited to, damage or loss of property or equipment, loss of profits or revenues, cost of replacement goods, or expense or inconvenience caused by service interruptions.

Any loss, corruption or destruction of data while using a LaCie drive is the sole responsibility of the user, and under no circumstances will LaCie be held liable for the recovery or restoration of this data. Under no circumstances will any person be entitled to any sum greater than the purchase price paid for the drive.

To obtain warranty service, call LaCie Technical Support. You may be asked to furnish proof of purchase to confirm that the drive is still under warranty.

All drives returned to LaCie must be securely packaged in their original box and shipped with postage prepaid.

IMPORTANT INFO: Register online for free technical support:
www.lacie.com/register
