



Made for ideas.

LACIE 5BIG THUNDERBOLT™ SERIES USER MANUAL



[CLICK HERE TO ACCESS UP-TO-DATE ONLINE VERSION](#)

of this document for the most recent content as well as for features such as expandable illustrations, easier navigation, and search capability.



INTRODUCTION

Welcome to the User Manual for the LaCie 5big Thunderbolt Series. With lightning-fast speeds through the Thunderbolt interface, this product is perfect for high-bandwidth applications such as HD video editing and workstation backup. Thanks to its five hard disks, you can configure the LaCie 5big into a range of RAID modes suitable for a variety of uses.



These pages will guide you through the process of connecting your LaCie product and will explain its features. If this manual doesn't answer your questions or if you are having trouble, consult the [Getting Help](#) page.

BOX CONTENT

Your box contains the following:

- LaCie 5big Thunderbolt Series
- External power supply (12V/12.5A)
- Thunderbolt cable
- 2-in-1 RAID mode change and drive removal tool
- CD with User Manual and software
- Cable management clasp
- Quick Install Guide

Important info: Please save your packaging. In the event that the product should need to be repaired or serviced, it must be returned in its original packaging.

MINIMUM SYSTEM REQUIREMENTS

Your system must meet certain requirements in order for your LaCie product to function properly. For a list of these requirements, please refer to the product packaging or consult the product support web page at www.lacie.com/support/.

VIEWS OF THE PRODUCT

FRONT VIEW

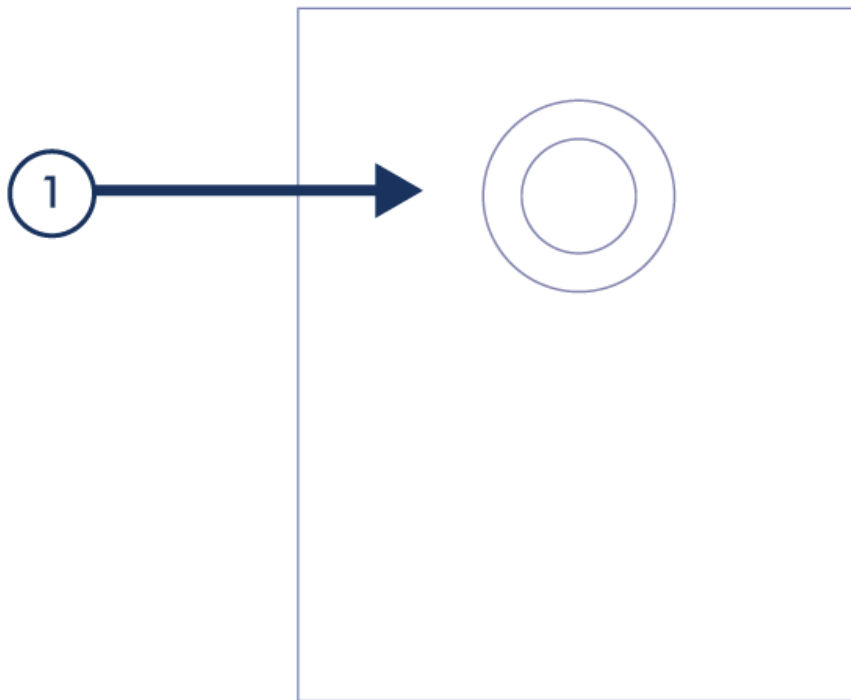

1. Activity LED and button

Front Button Functions

The front LED is also a button. Consult the following table for front button functions. Note that **Passive Mode** means that the product is on but the disks are idle. This allows you, for example, to daisy chain compatible Thunderbolt devices to a host computer via the LaCie 5big, without causing the 5big's disks to spin up. This lets you control energy usage and limit unnecessary wear and tear on the 5big's disks.

Product State	Front Button Action	Result
Product is turned on, connected to a host, and disks are idle	Press and release	Disks spin up
Product is turned on, connected to a host, and disks are spinning	Press and hold for 5 seconds	Enter passive mode
Passive mode	Press and release	Disks spin up (leave passive mode)

REAR VIEW

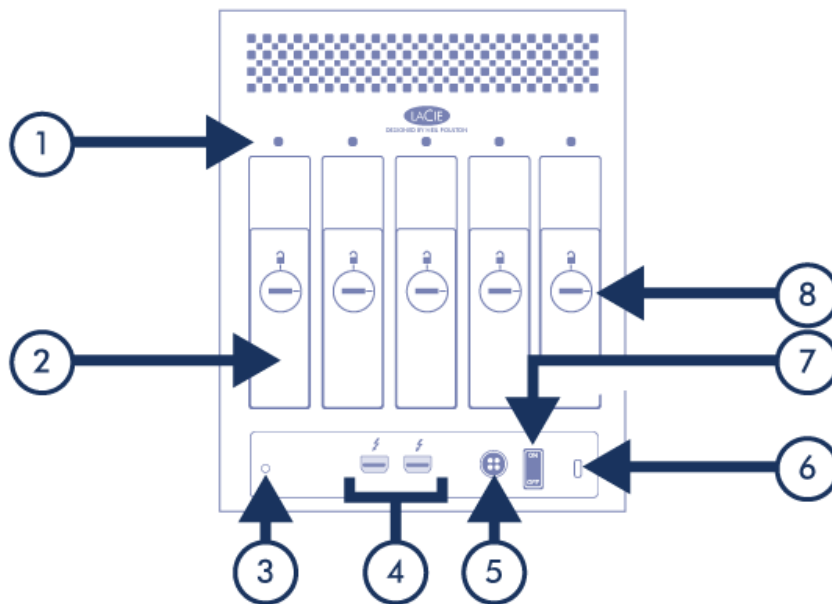

1. Drive status LEDs
2. Swappable disk trays
3. Cable management clasp port
4. Thunderbolt ports
5. Power supply
6. Kensington™ lock port
7. On/off
8. Disk tray lock





CABLES AND CONNECTORS

THUNDERBOLT

Your LaCie product features Thunderbolt technology, the most flexible interface ever created. This exciting new high-speed cable technology connects your computers and electronic devices together like never before. Thunderbolt technology supports two 10Gb/s bi-directional channels from a single port, the fastest data connection available on a personal computer. At 10Gb/s, a full-length HD movie can be transferred in less than 30 seconds.

Thanks to support for both data streams and mini DisplayPort video, you can connect either a storage peripheral or a display to a Thunderbolt port. However, it's not possible to use a mini DisplayPort cable to connect a storage peripheral to a Thunderbolt port. You must use a Thunderbolt cable.

For more information, see www.lacie.com

Connector Face (to computer)	Cable End (to computer)	Cable End (to product)	Connector Face (to product)
			

CABLE MANAGEMENT

This product includes a cable lock, a small plastic clasp that prevents cords from accidentally disconnecting.

Important Info: It's impossible to disconnect the cable lock without destroying it.

To use the cable lock:

1. Insert the clasp's locking head into the lock slot.
2. Make sure that the interface cable is connected to the product.
3. String the interface cable through the open cable lock gate.
4. Close and snap in place the cable lock gate.

LED & BUZZER

Your LaCie product features a multi-functional LED/button on the front, as well as five drive status LEDs on the rear. It also features a temperature alert buzzer.

FRONT LED

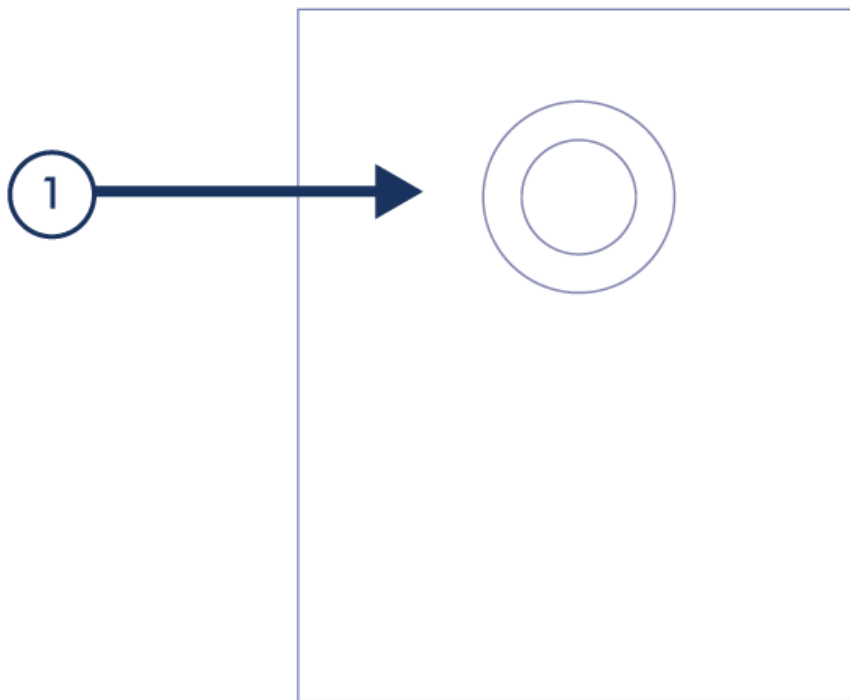

State	Indication
Off	Product is turned off or power supply is disconnected
Solid blue	Turned on
Solid red	Fan disconnected or non-functional

DISK LEDS

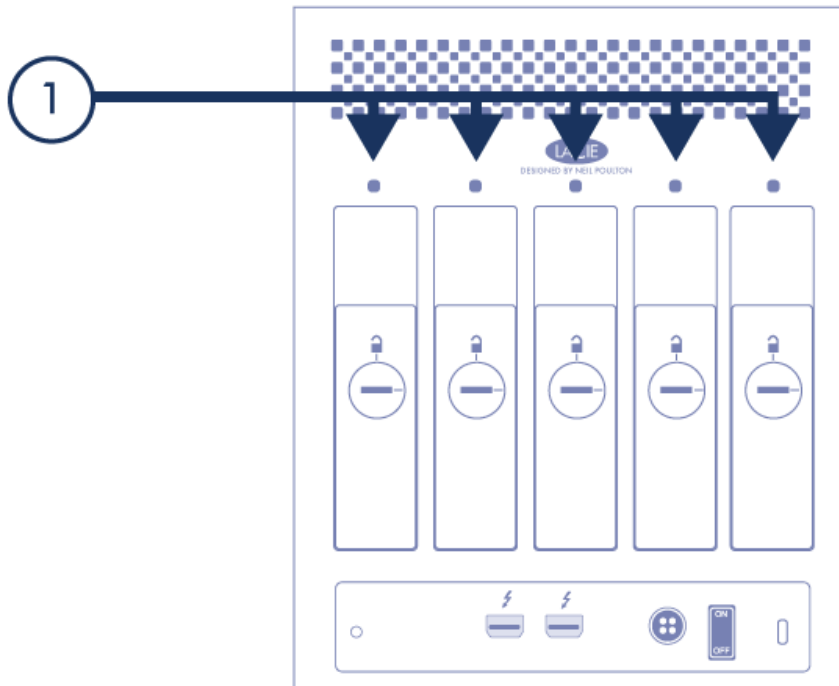

State	Indication
Off	No disk or non-functional disk
Solid blue	Disk OK but not in use
Flickering blue	Disk activity

BUZZER

A buzzer will sound to indicate a temperature alert. Simultaneously, the front LED will turn red.

You can turn off the buzzer by pressing the front button, but the LED will stay red.

In order to protect the hard disks from excessive heat, please discontinue use of the product. Contact [LaCie technical support](#).

GET CONNECTED

Please follow the setup steps in the order they are given to ensure that your LaCie 5big's volumes mount correctly on your computer.

STEP 1 - INSTALL DISKS

If your LaCie 5big shipped without disks, first install your own hard disks before continuing with these steps. Refer to [Install Disks](#) for details.

STEP 2 - CONNECT THE THUNDERBOLT CABLE

Connect the Thunderbolt cable from the LaCie 5big to the computer.

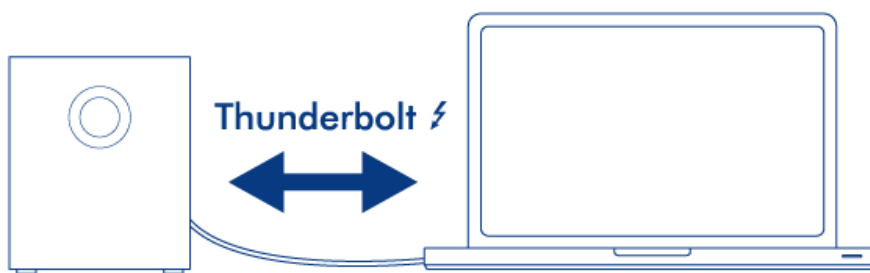

STEP 3 - CONNECT THE POWER CABLE

Connect the power supply to a wall outlet and to the LaCie 5big.

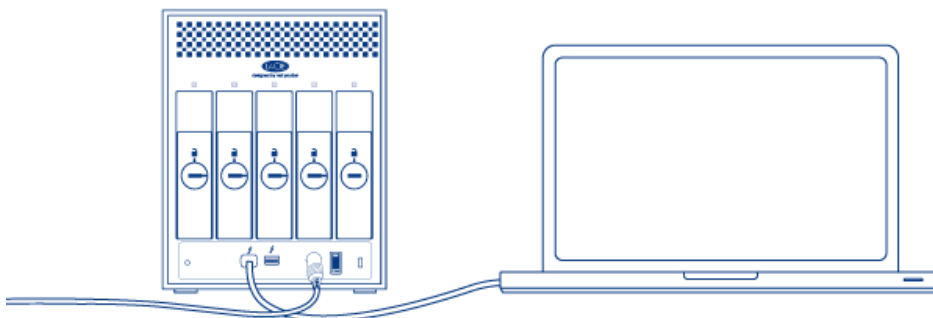

STEP 4 - TURN ON THE PRODUCT

Turn on the product using the power switch.

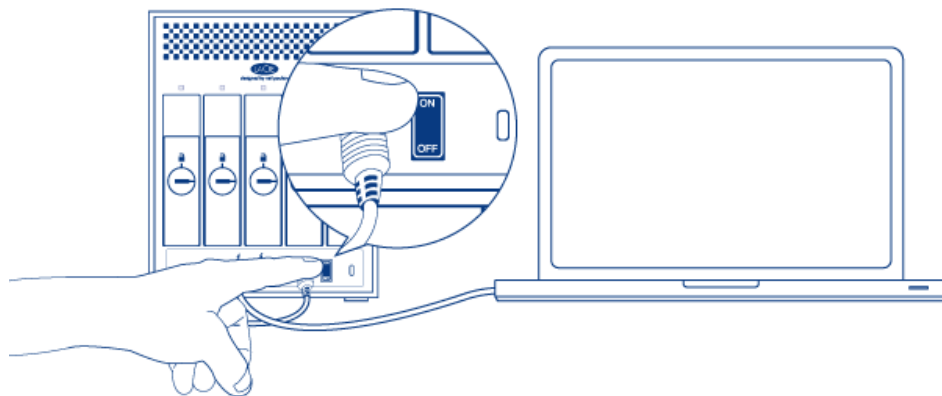

If your LaCie 5big shipped with disks, a single RAID 0 volume will mount on the desktop. If it shipped without disks, since no RAID array has exists, a volume for each installed disk will mount on the Desktop. If nothing mounts, check [Getting Help](#).

For details on changing or setting up a RAID array, refer to [About RAID](#).

INSTALL DISKS

HARD DISK COMPATIBILITY NOTES

- When adding a new disk to an empty slot, consider a [LaCie 5big Spare Drive](#). LaCie disks are specially prepared and optimized for use with LaCie RAID products.
- If you are installing non-LaCie disks, please check the list of supported [Hard Drives](#). LaCie cannot guarantee performance or functionality when using unsupported disks.
- Only 3.5" SATA II or SATA III disks may be used in the enclosure.
- LaCie recommends selecting disks that are equal in storage capacity. For example, if the first disk has a 1TB disk, fill all the slots with 1TB disks.

INSTALL DISKS

1. Turn off the product.
2. Remove empty disk tray(s). The disk tray(s) may be locked. To unlock, use the included disk drawer key to rotate the lock.

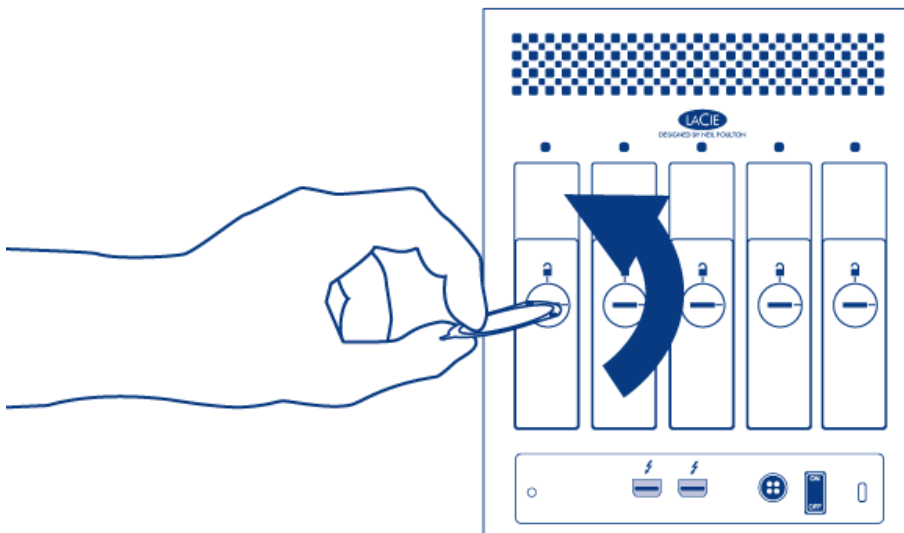

3. Draw out the disk tray by inserting your finger into the space behind the disk tray handle and pulling. Repeat the process if you are adding a second disk.

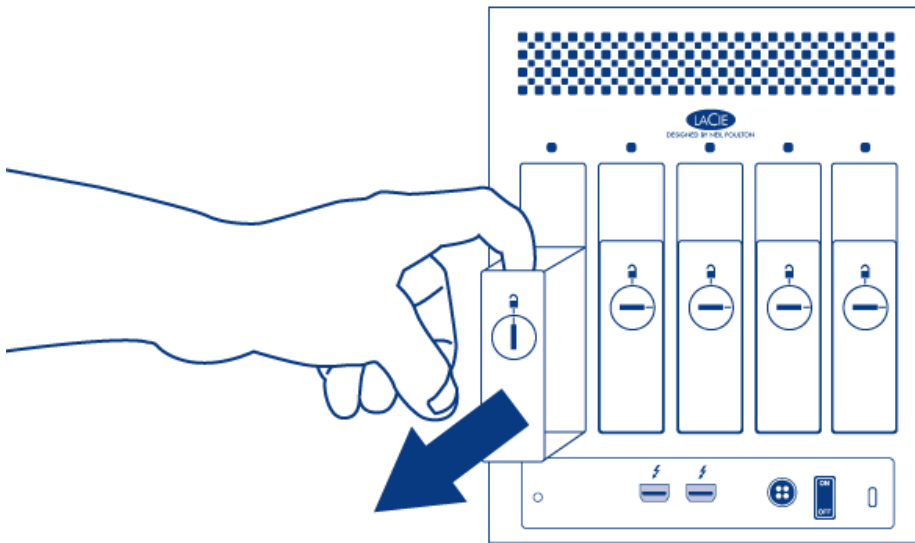

4. Install disk(s) in disk tray(s):

1. Place the empty disk tray onto the flat work area with the handle on the bottom left.
2. Many disks have a label on one side and the printed circuit board on the opposite side. With its label side facing up, gently place the hard disk within the disk tray. Keep the side with the printed circuit board on the work space and the SATA connector facing to the right. The four tray screw slots should align with the disk's four screw holes.
3. Using the Phillips head screwdriver, carefully fasten all four screws into the four tray slots. Do not over tighten the screws. Repeat the process if you are installing multiple disks.

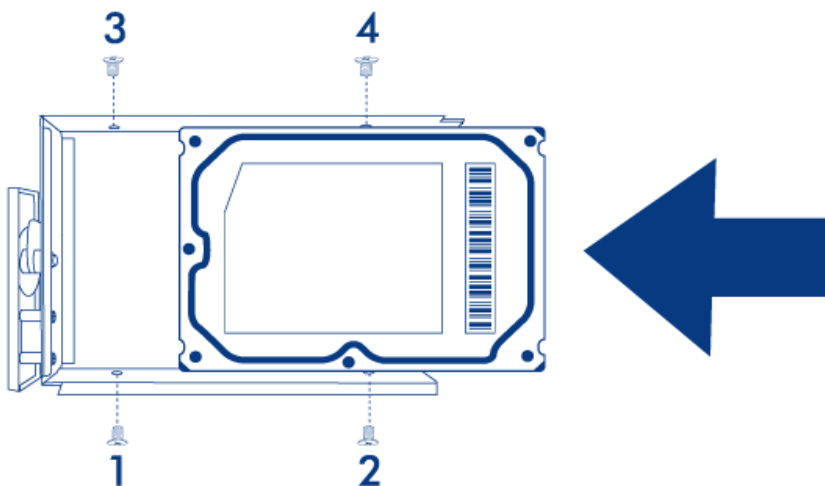

5. Insert full disk tray(s). Carefully insert the full disk tray into an empty disk slot. Gently push the disk tray handle firmly until you feel it snap into place. The disk tray handle should be flush with the back of the enclosure. If you are adding the second disk, insert it next.

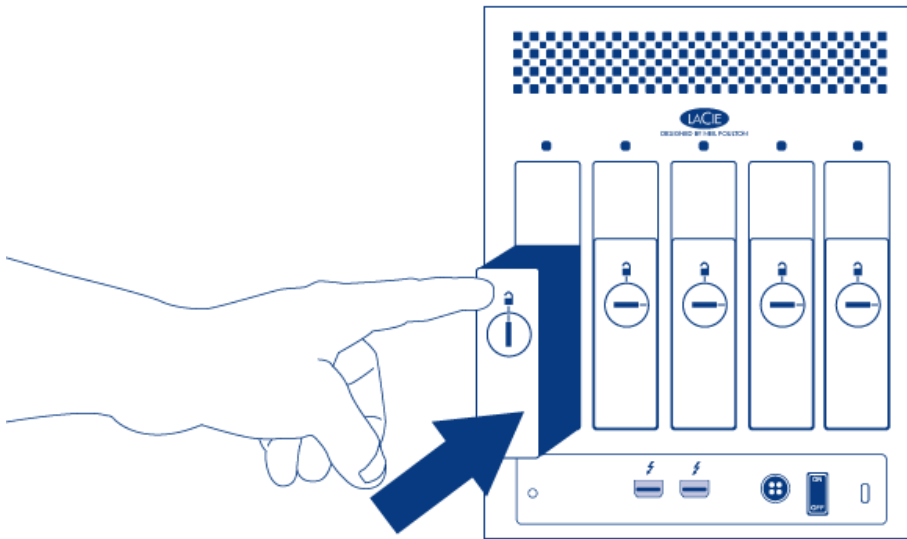

6. Use the disk lock tool to lock the disk(s) in place.

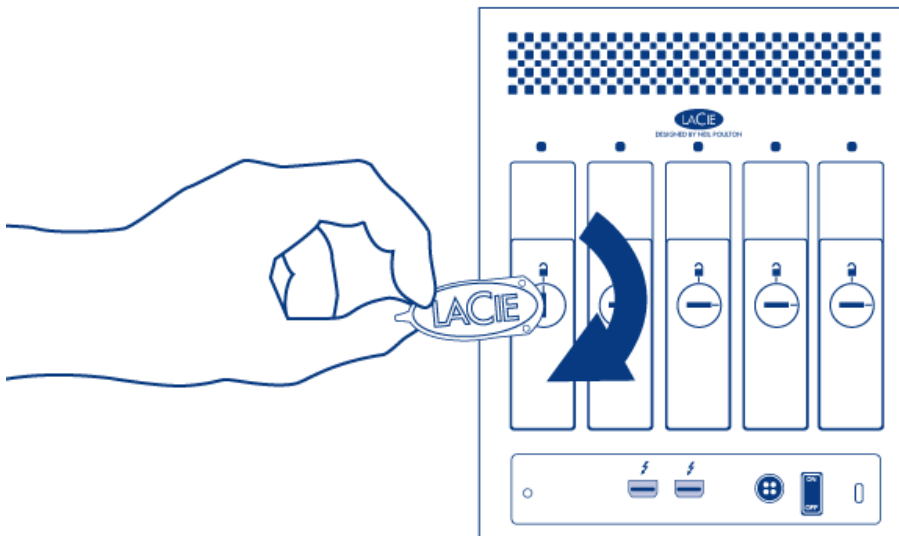

7. Move on to the next chapter, [Get Connected](#).

Caution: To avoid potential problems caused by electrostatic discharge (ESD), it is recommended that you do not touch the hard disk's printed circuit board. As a further precaution against ESD, use an anti-static wristband or an anti-static mat to ground yourself when handling the hard disk.

UNMOUNT VOLUME(S)

USB, FireWire, Thunderbolt, and eSATA external devices feature “plug & play” connectivity, which means that your LaCie storage can be connected and disconnected while the computer is running. To prevent failures, however, it is important to follow these steps when disconnecting your device.

Drag the storage device icon to the Trash. (The icon pictured below is a generic USB device icon. Your LaCie storage may be represented by an icon that looks like the device itself.)

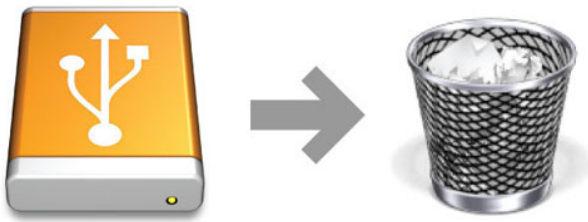

When the icon disappears from the desktop, the storage device can be disconnected.

ABOUT RAID

The LaCie 5big Thunderbolt Series is compatible with a range of RAID options for a variety of uses. It's preconfigured as a RAID 0 striped set to unleash its full speed potential for data-intensive applications such as HD video editing. Or opt for a RAID 1 mirrored set for excellent data security. Alternatively, you could go without RAID and configure it in a JBOD. Since in a JBOD configuration all disks mount independently, many people use JBOD so that they can assign each disk to a specific data storage task. For instance, you could put backups performed on Monday on the first disk, Tuesday on the second, etc.

Another use case is a mixed configuration: three disks in a RAID 0 for speed-intensive applications and two disks in a RAID 1 for backup.

MODIFY RAID

In order to create a RAID array, you'll need two disks (RAID 1) or at least two disks (RAID 0) that aren't already included in another RAID. Follow the below links for instructions:

- [Delete a RAID Array](#)
- [Create a RAID Array](#)

RAID MODE OPTIONS

Striped RAID Set (RAID 0)

A Striped RAID Set pairs the drives within an enclosure for enhanced transfer rates. Data is stored across all disks in a striped pair, allowing them to share the demands of reading and writing files. Unlike a Mirrored Striped Set (RAID 1), the available capacities of each disk are added together for maximum storage availability. With its improved read/write seek rates and maximum storage capacity, a Striped RAID Set is a great complement to the extraordinary performance already offered by Thunderbolt technology. Data is also easy to access since a RAID 0 stripe creates one logical volume that mounts on the desktop. One disadvantage of a Striped RAID Set is the lack of built-in data security. In the event that one disk fails, all the files become inaccessible since parts of each string of data are written across the striped pair. Therefore, LaCie highly recommends backing up data stored on a Striped RAID Set at least once a day. You can back up the data to your computer's internal disk or another storage medium with sufficient capacity.

Mirrored RAID Set (RAID 1)

In a Mirrored RAID Set, the physical disks are mirrored together so that one single logical volume mounts on the desktop. Please note that the combined storage will not exceed the available capacity of the lowest-capacity single disk. All data is saved simultaneously on each disk which means that files will not be lost if one drive should fail. A Mirrored RAID set always consists for two disks. Therefore, since the LaCie 5big has five disks, you can create two separate sets (each with two disks). A total of three volumes will then mount on your computer: one for each of the two mirrored sets, and one single-disk (and non-mirrored) volume.

JBOD

JBOD is not technically a RAID mode, since all disks are independent, with no collective properties. Each physical disk is mapped to a different logical volume. As a result, one volume for each disk will mount on the computer. No protection is provided, so if a disk fails, all data contained on that disk is lost.

LACIE RAID MONITOR

LaCie RAID Monitor runs in the background, keeping tabs on the health of your LaCie RAID product. It alerts you to any disk-related problems, so you can fix any issues immediately.

If you do not have the LaCie RAID Monitor installer, go to the [Downloads](#) page for the latest version.

INSTALLATION

1. Click twice on the installer. It is a *.dmg* file.
2. Click twice on **LaCie RAID Monitor.pkg**.



3. Click **Continue**.

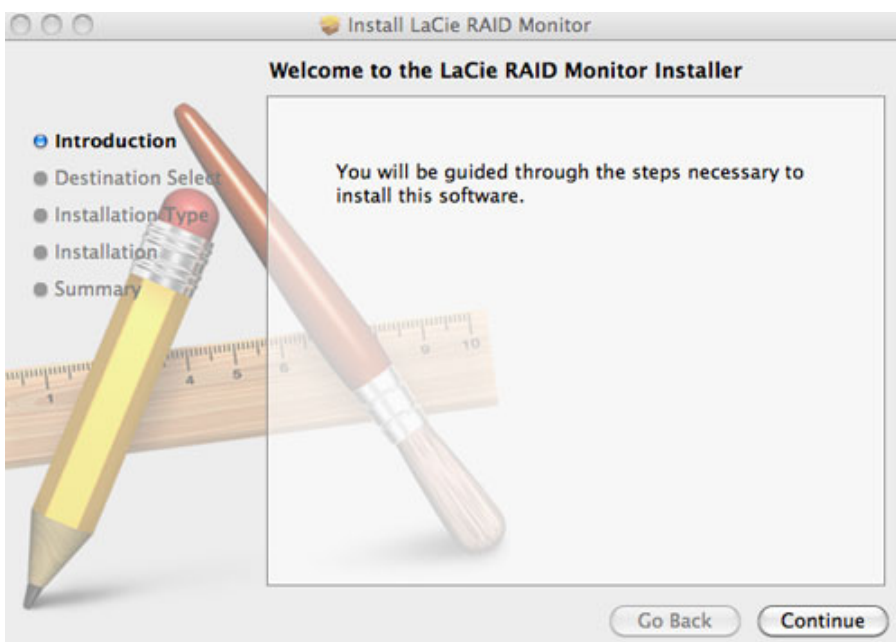

4. Click **Install**.

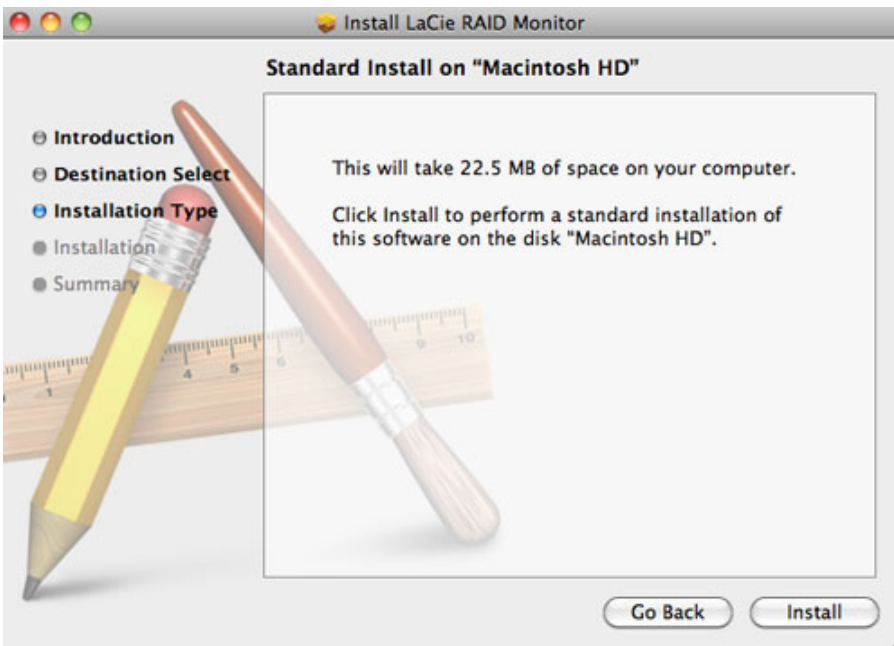

5. Your computer may ask you to enter the Administrator password to continue.

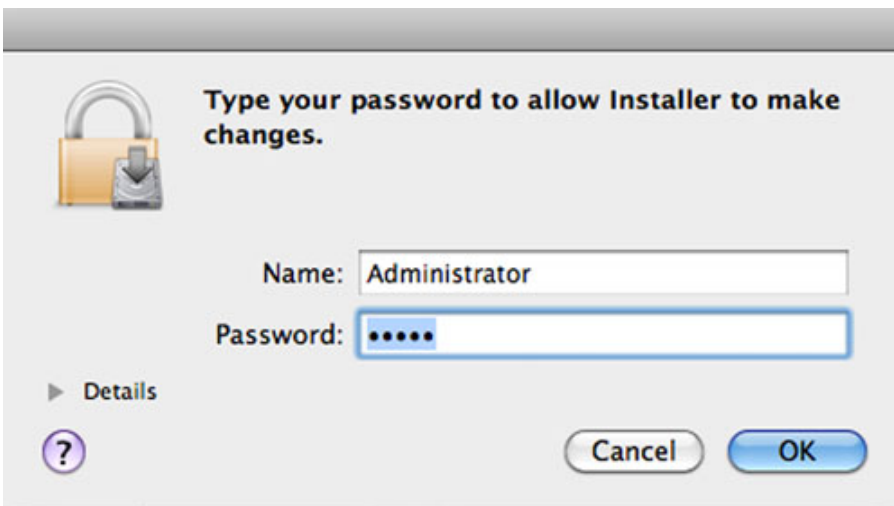

6. The software has been successfully installed. Click **Close** to exit the installer.

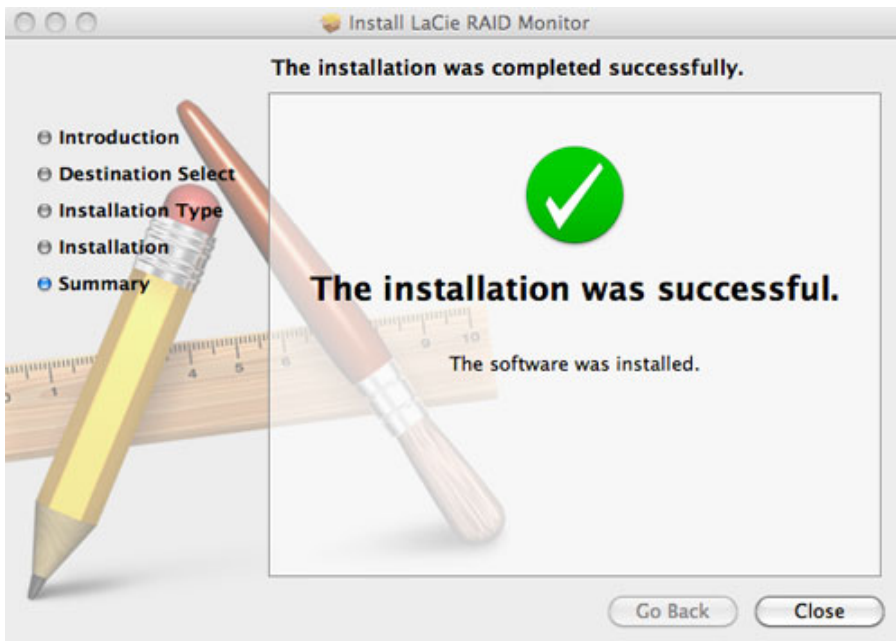

7. LaCie RAID Monitor will launch automatically.

USAGE

LaCie RAID Monitor will launch automatically following a successful installation. The utility runs in the background while you work, monitoring the LaCie 5big storage to verify the health of the RAID. To manually check the health of your LaCie 5big:

1. Go to the menu bar to click on the RAID Monitor icon.

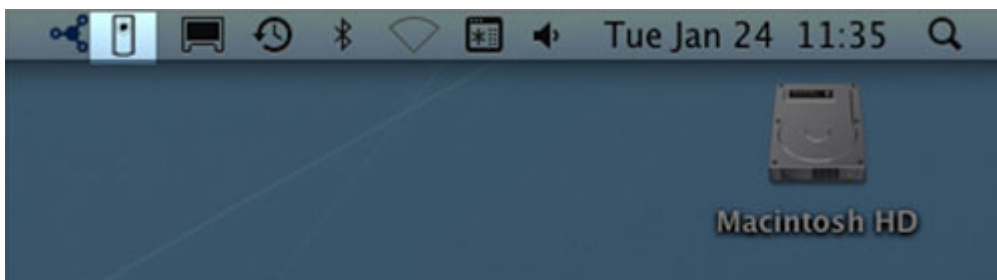

2. Select **Open LaCie RAID Monitor**.

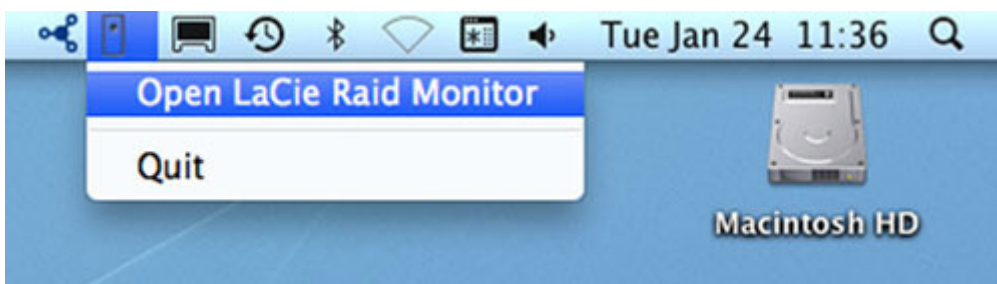

The LaCie RAID Monitor gives you an easy color-coded reference to know instantly if your LaCie 5big is in good health:

- Green indicates that the RAID is in working order.

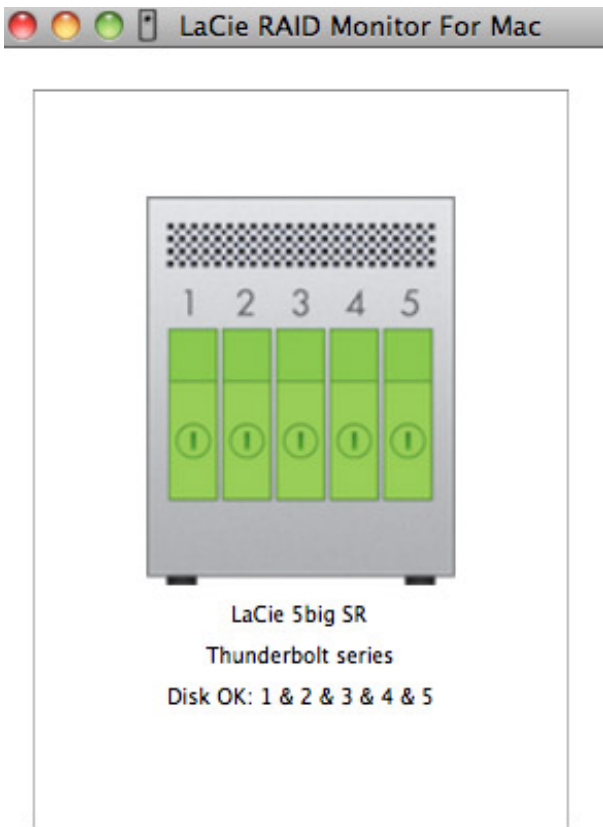

- Red indicates a problem with one or more disks in the RAID.

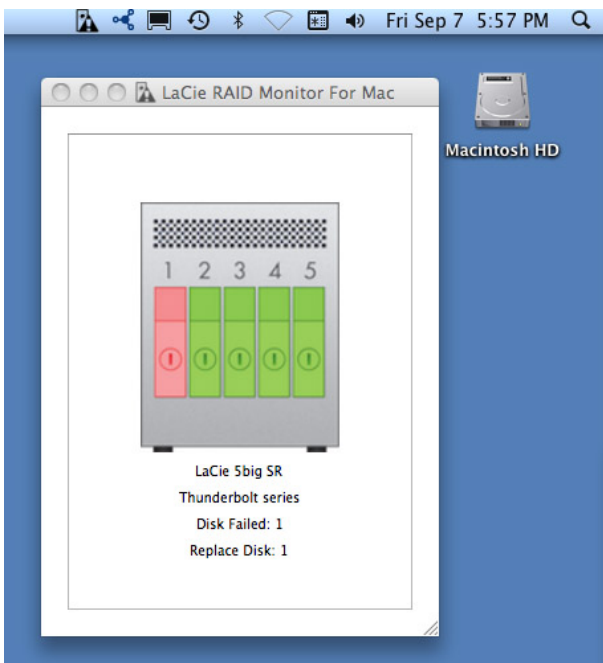

You do not have to launch LaCie RAID Monitor to receive alerts. Should one or more disks encounter problems, the LaCie RAID Monitor icon in the menu bar will blink with an exclamation mark inside a triangle.

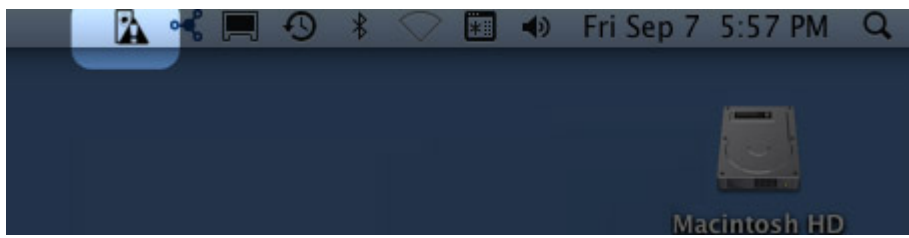

If you receive the alert, open LaCie RAID Monitor for more details.

UNINSTALLATION

Run the Uninstaller from the dmg file. Dragging the program icon to the Trash will not completely remove the utility from your computer.

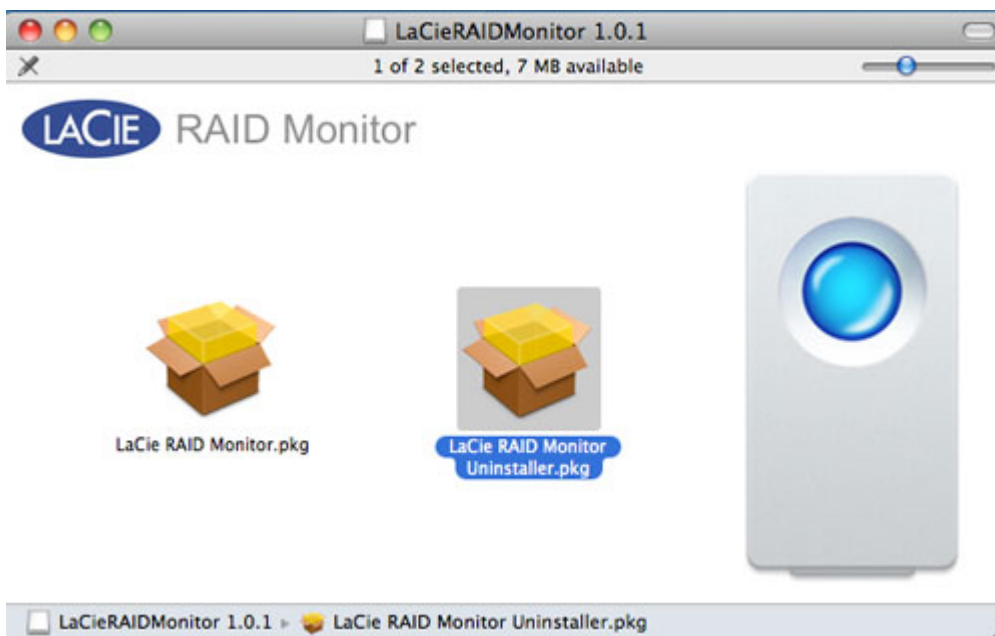

DELETE A RAID ARRAY

Follow these steps to delete a RAID array.

Caution: Deleting a RAID array destroys data stored on the disks involved in the array. Back up data before following these steps.

1. Make sure the product is turned on and connect to your Mac as described in [Get Connected](#).
2. Navigate to the Finder.
3. Go to the pulldown menu **Go > Utilities**.

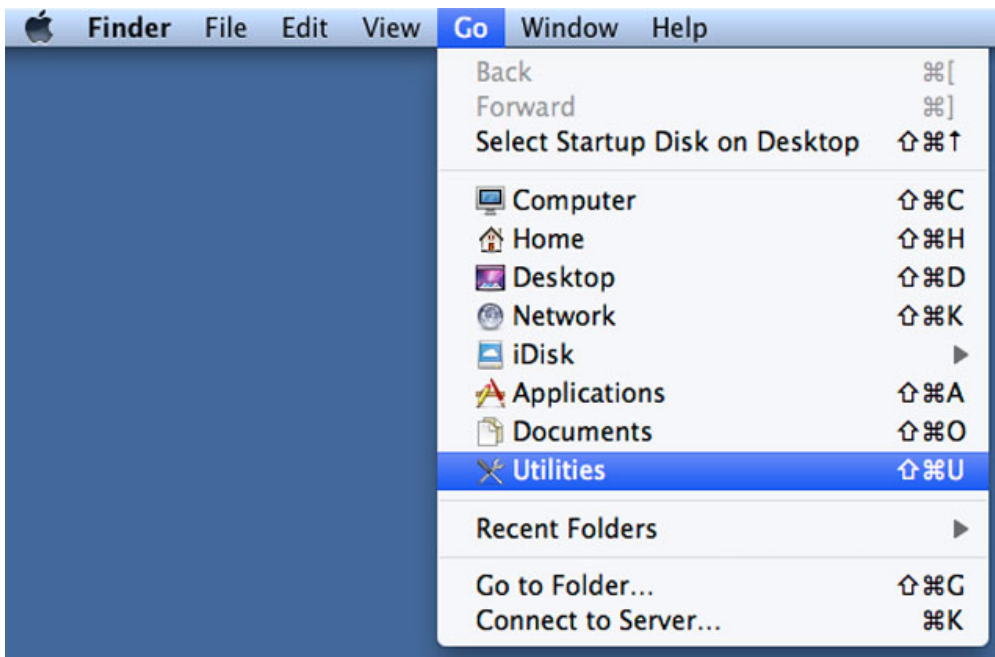

4. The Utilities window will open. Click twice on the application **Disk Utility**.
5. Connected storage devices are listed on the left side of the Disk Utility window. Any RAID arrays created using Disk Utility are also listed.

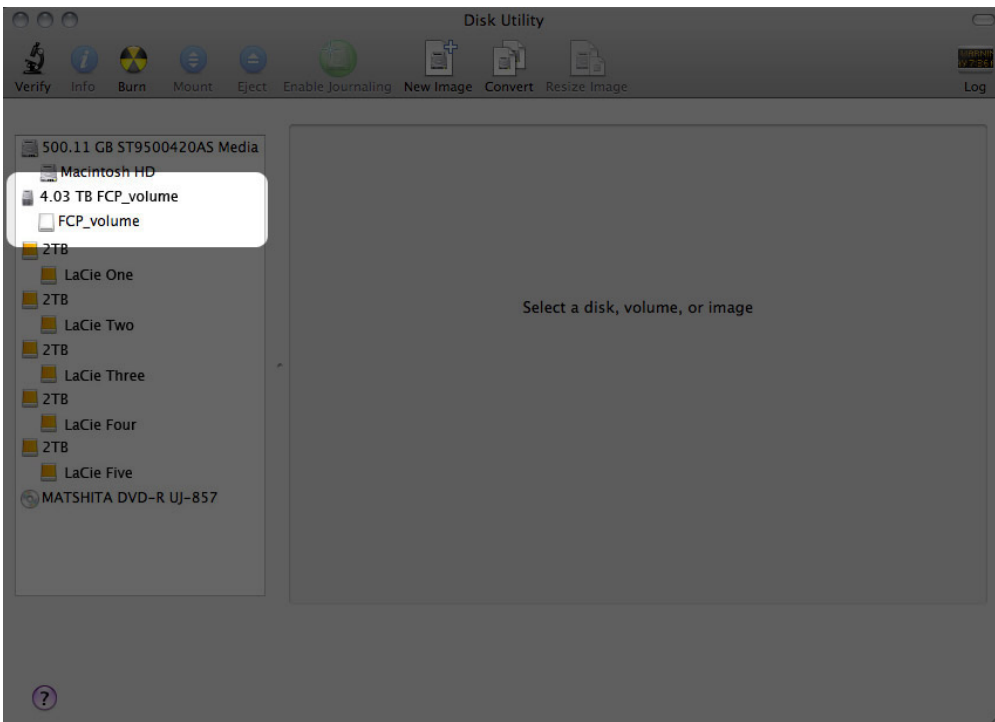

6. Click on the RAID array icon in this area, then click the **RAID** tab.

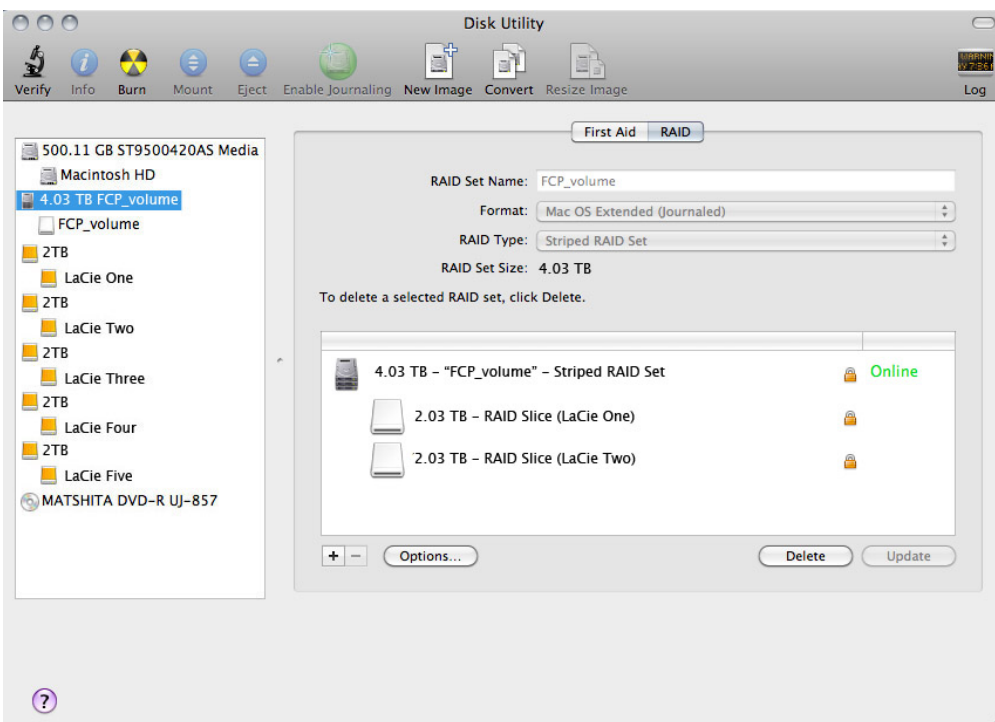

7. Click the **Delete** button, then confirm the deletion.

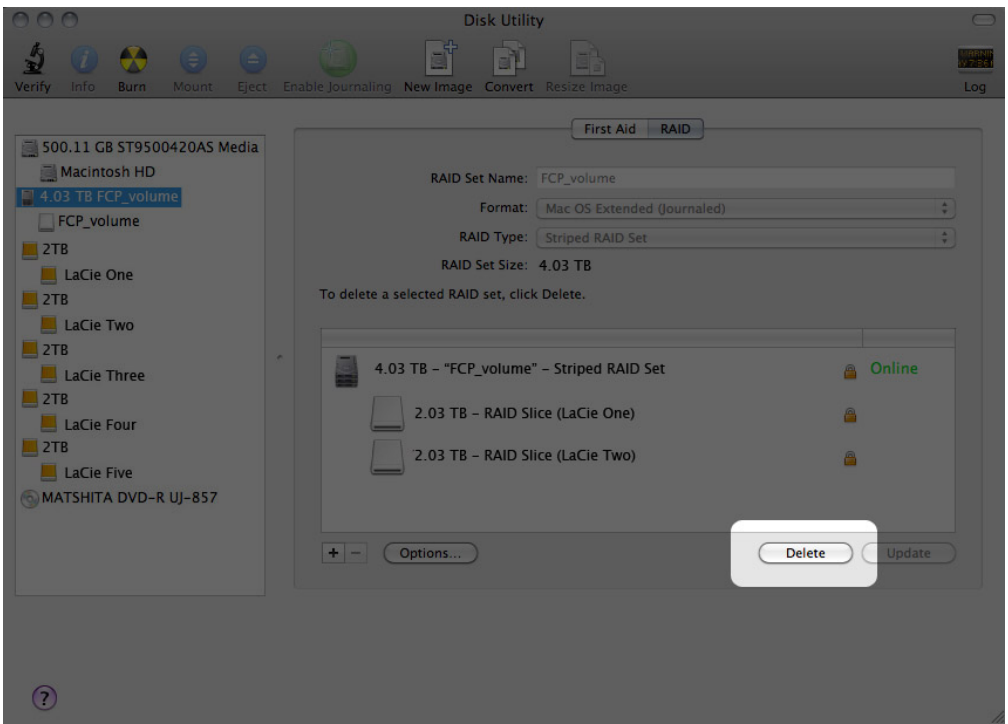

CREATE A RAID ARRAY

In order to create a RAID array, you'll need two disks (RAID 1) or at least two disks (RAID 0) that aren't already included in another RAID. If your LaCie 5big shipped with disks, you'll first need to delete the factory default RAID 0 array before you can create a new array (refer to [Delete a RAID Array](#) for instructions).

1. If your LaCie 5big shipped without disks, install them first (see [Install Disks](#)). Make sure the product is turned on and connect to your Mac as described in [Get Connected](#).
2. Navigate to the Finder.
3. Go to the pull-down menu **Go > Utilities**.

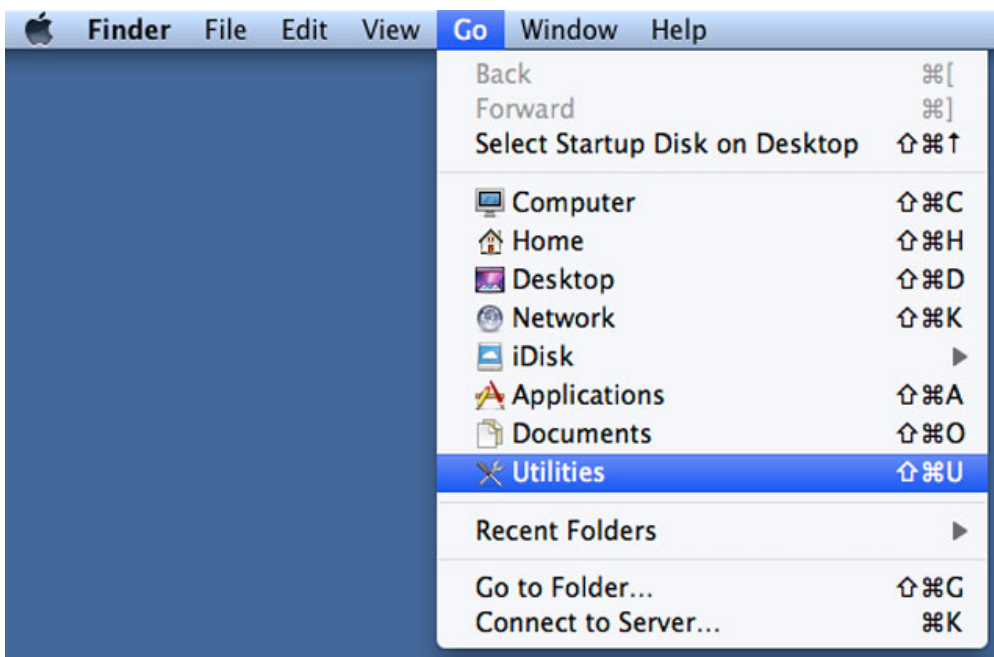

4. The Utilities window will open. Click twice on the application **Disk Utility**.
5. Connected storage devices are listed on the left side of the Disk Utility window.

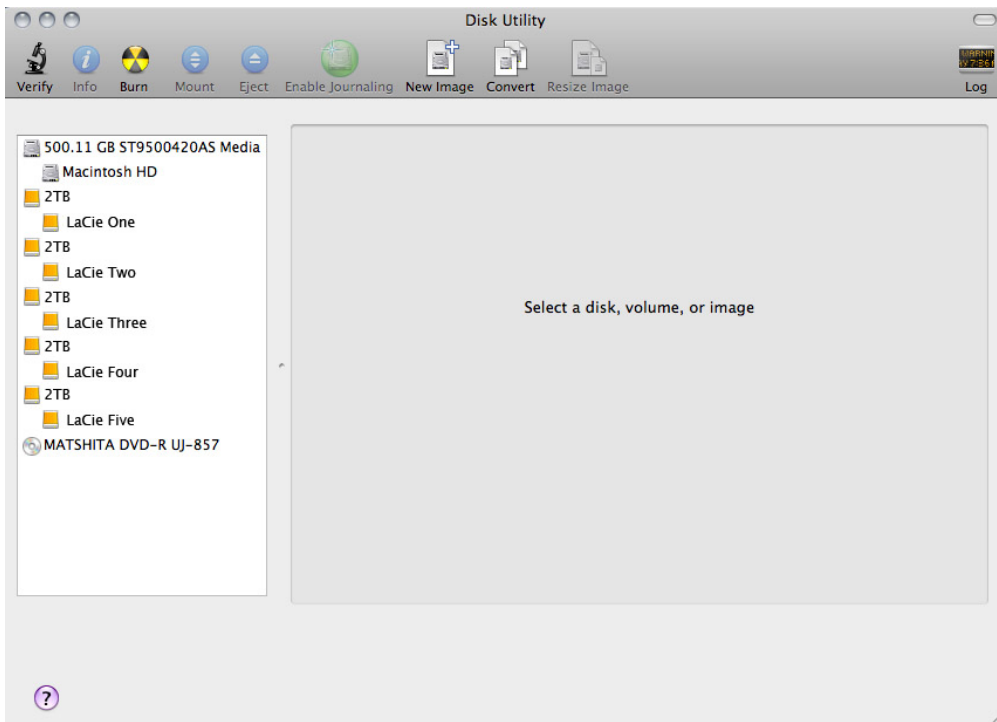

6. Click on one of the LaCie disks to see the action tabs. Click the **RAID** tab.

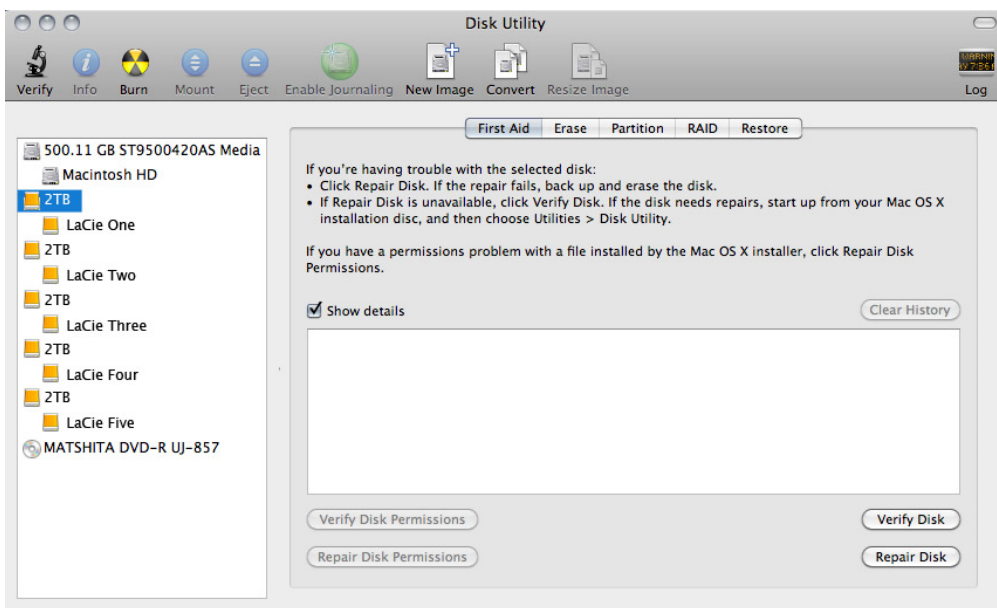

7. The RAID tab includes three important settings: *RAID Set Name*, *Format*, and *RAID Type*.

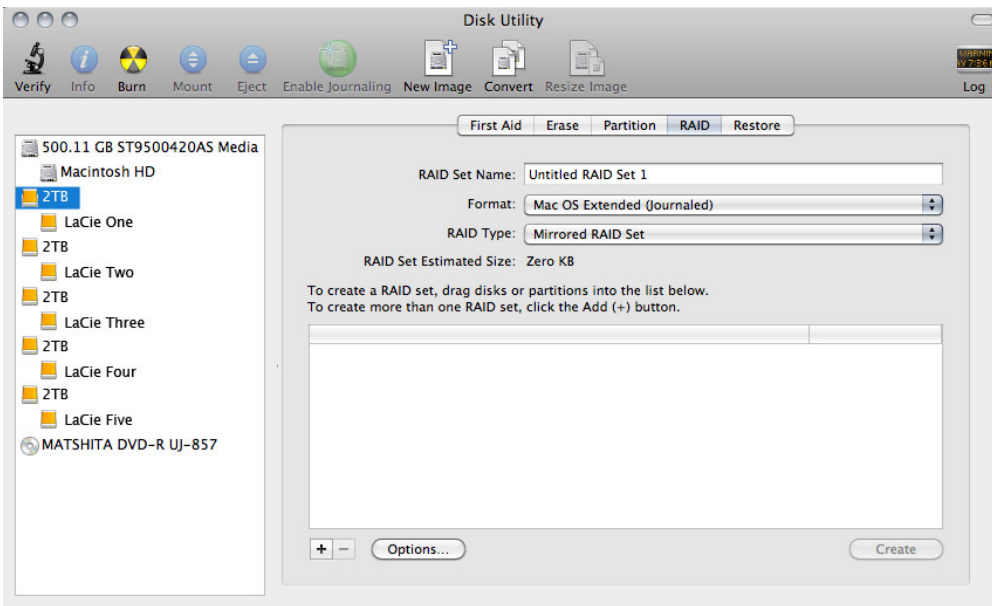

8. Clicking on the **Format** pulldown menu shows the file system formats available for the disks when creating the RAID. Select **Mac OS Extended (Journaled)**.

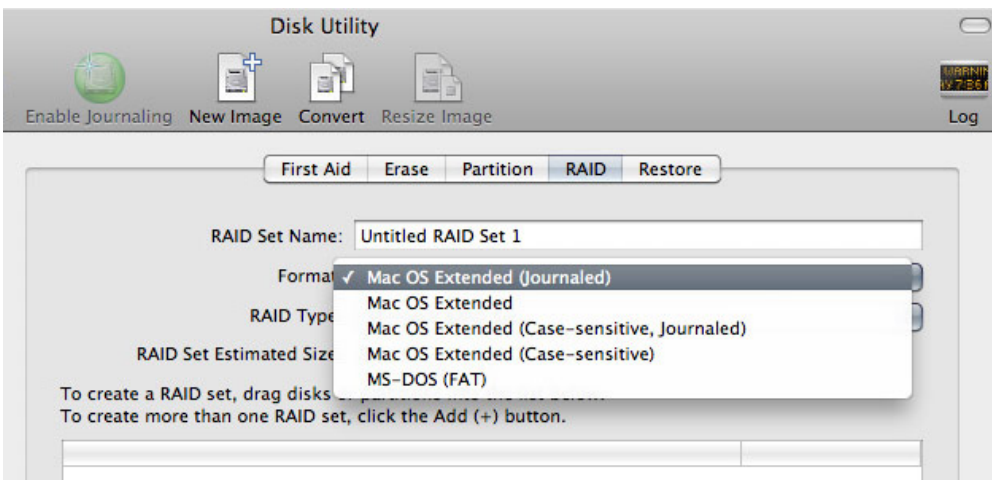

9. Clicking on the **RAID Type** pulldown shows the available RAID configurations. See [About RAID](#) for information on the different RAID options.

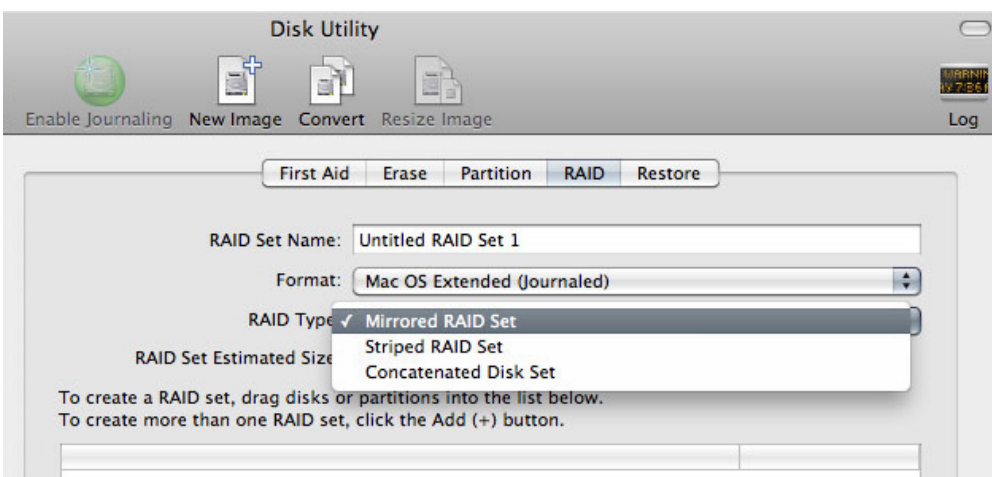

10. Fill in a name for your Striped or Mirrored RAID Set in the field **RAID Set Name**.

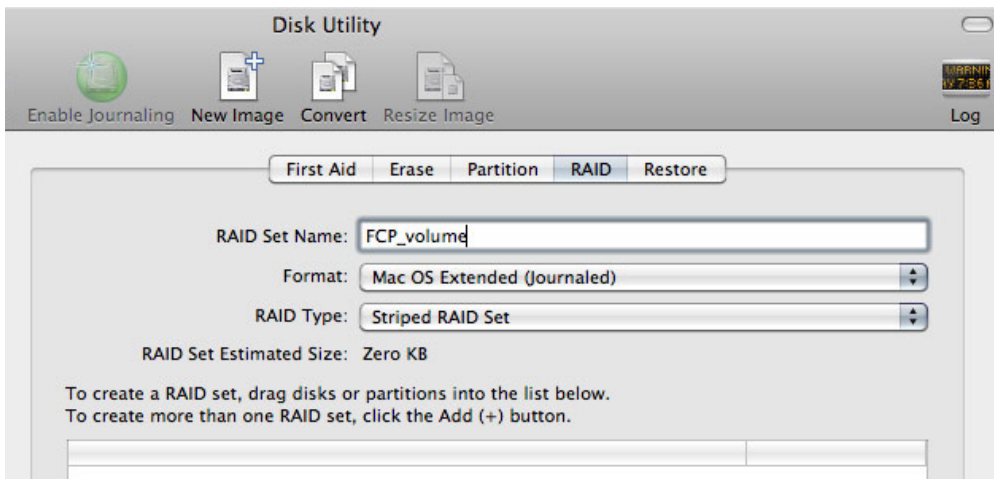

11. Drag one of the disks to the empty field in the middle of the RAID tab.

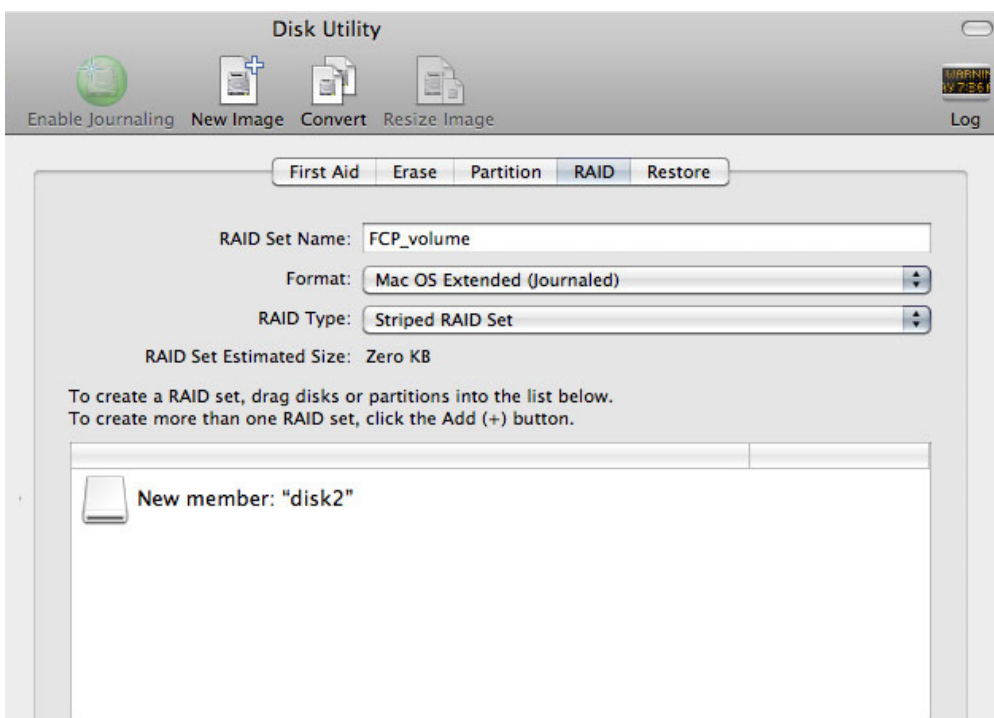

12. Drag additional disk(s) to the same field in the middle of the RAID tab. Note that RAID 0 arrays can include two or more disks, while a RAID 1 array can only be composed of two disks.

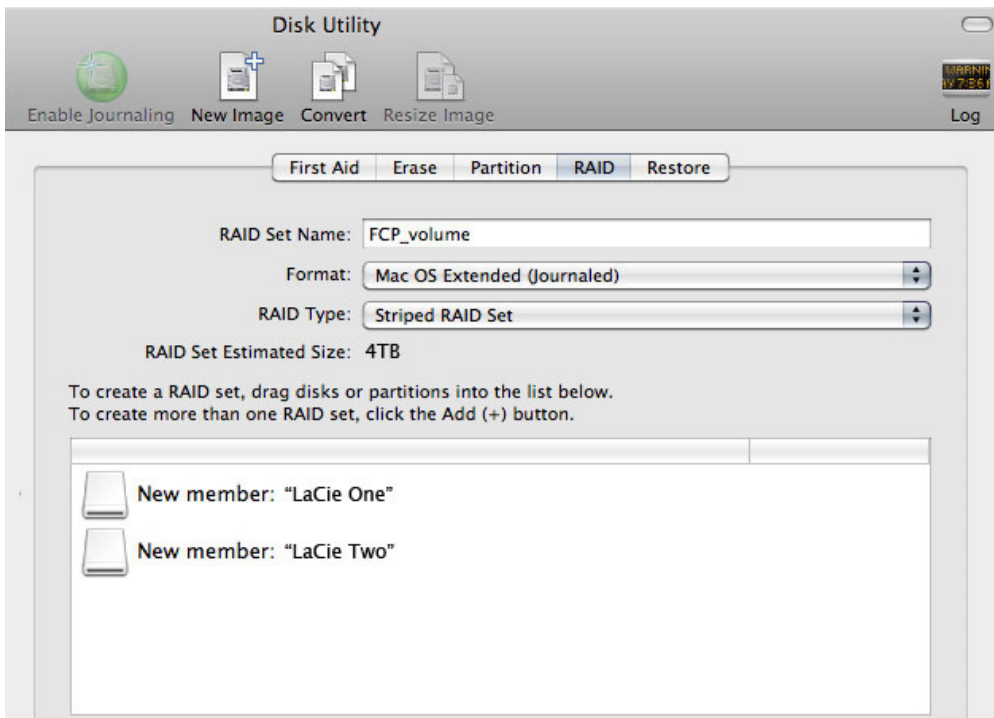

- To change the RAID Block Size, click the **Options...** button on bottom of the window. While this example shows the default, you may want to choose a higher RAID Block Size if you will be working with larger files (i.e. HD video and audio). Please see your audio/video software's user manual for the recommended RAID Block Size. Once you have chosen a RAID Block Size, click **OK**.

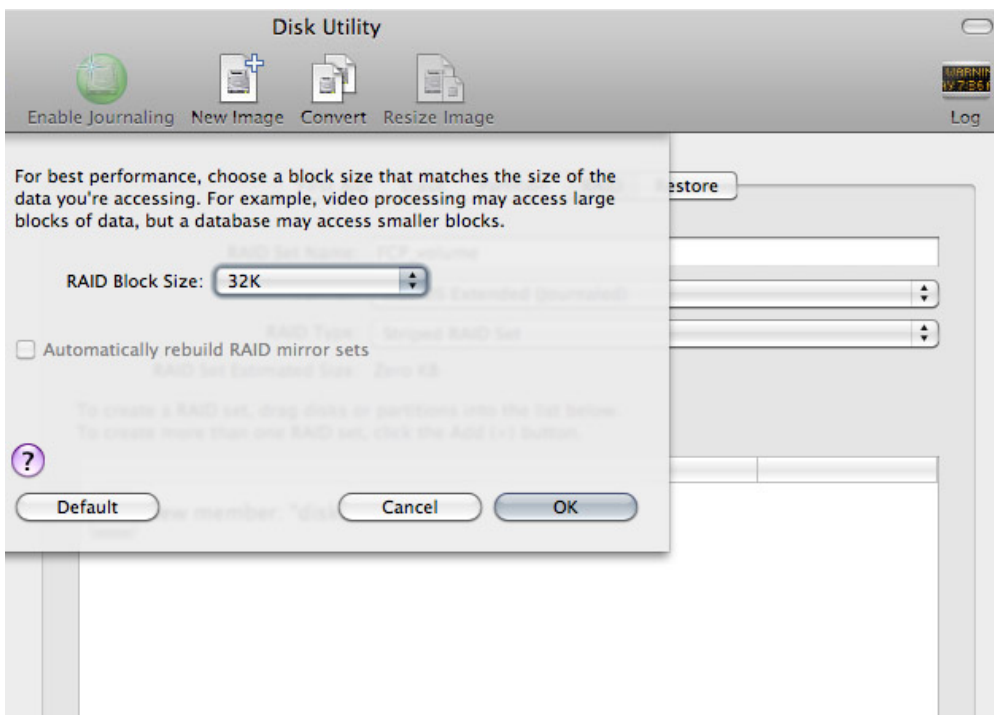

- Click **Create** on the bottom of the window to begin building the RAID.
- Click **Create** in the pop-up window.
- Please be patient while Disk Utility configures the RAID. The RAID Set will appear on the desktop as a single drive icon.



REPLACE A DISK

If you experience a disk failure, follow the steps below to install a new one. If you need instructions on installing disks in a LaCie 5big that shipped without disks, refer to [Install Disks](#).

1. Refer to the disk compatibility notes in [Install Disks](#).
2. Turn off the product.
3. Remove disk tray(s) for disk(s) to be replaced. The disk tray(s) may be locked. To unlock, use the included disk drawer key to rotate the lock.

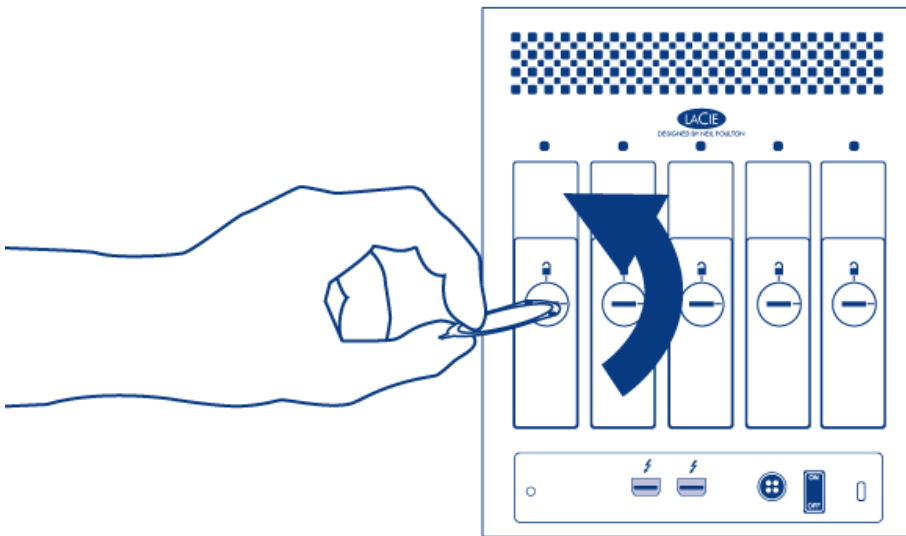

4. Draw out the disk tray by inserting your finger into the space behind the disk tray handle and pulling. Repeat the process if you are replacing multiple disks.

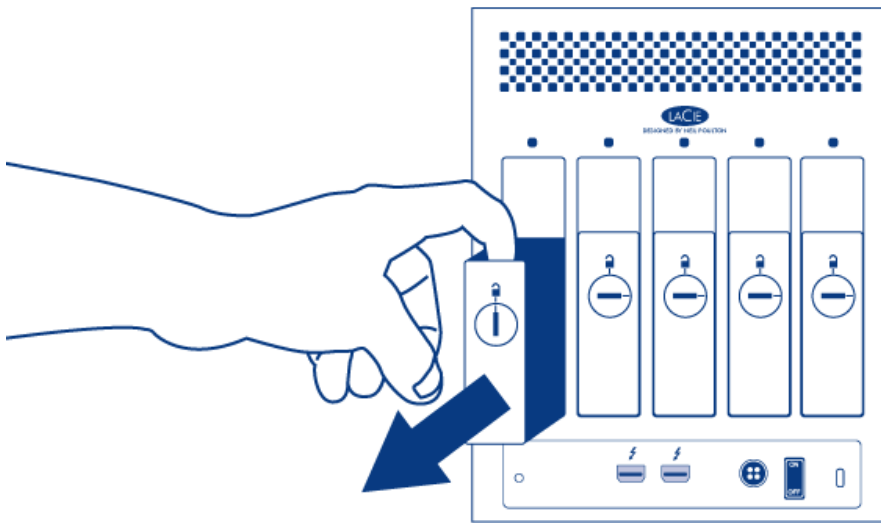

5. Uninstall disk(s) from disk tray(s):

1. Using the Phillips head screwdriver, carefully unfasten all four screws from the four tray slots. Repeat the process if you are installing multiple disks.

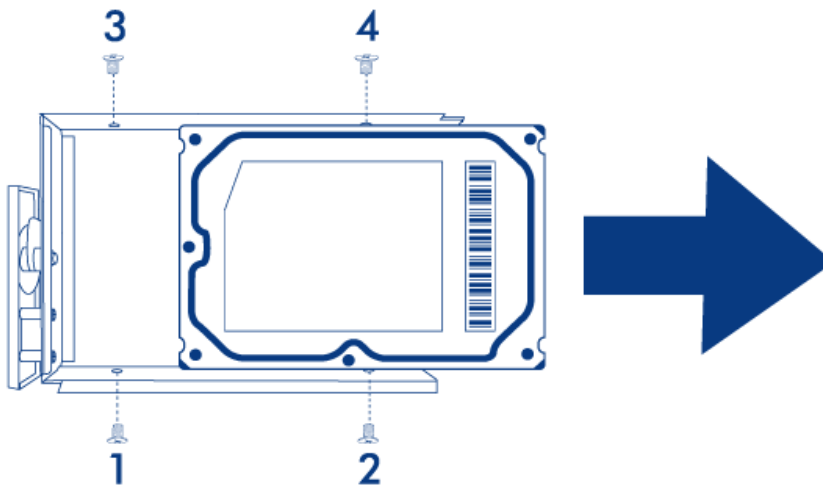

2. Slide the disk out of the disk tray.

6. Install new disk(s) in disk tray(s):

1. Place the empty disk tray onto the flat work area with the handle on the bottom left.
2. Many disks have a label on one side and the printed circuit board on the opposite side. With its label side facing up, gently place the hard disk within the disk tray. Keep the side with the printed circuit board on the work space and the SATA connector facing to the right. The four tray screw slots should align with the disk's four screw holes.
3. Using the Phillips head screwdriver, carefully fasten all four screws into the four tray slots. Do not over tighten the screws. Repeat the process if you are installing multiple disks.

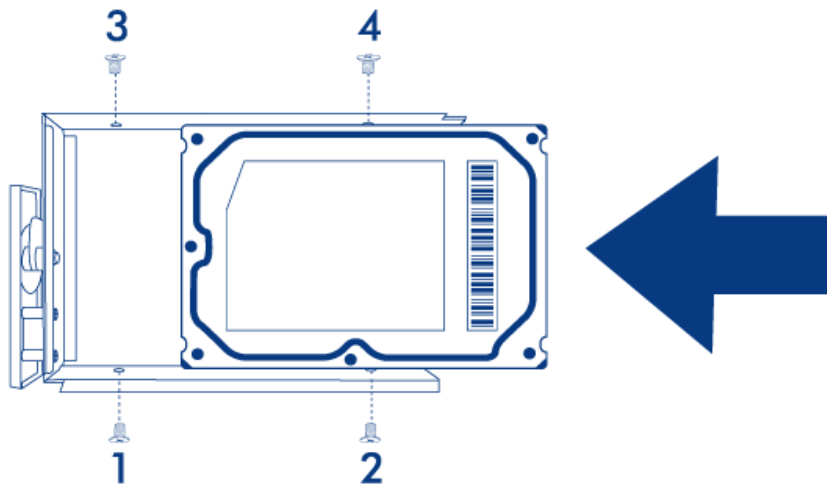

7. Insert full disk tray(s). Carefully insert the full disk tray into an empty disk slot. Gently push the disk tray handle firmly until you feel it snap into place. The disk tray handle should be flush with the back of the enclosure. If you are adding multiple disks, insert it next.

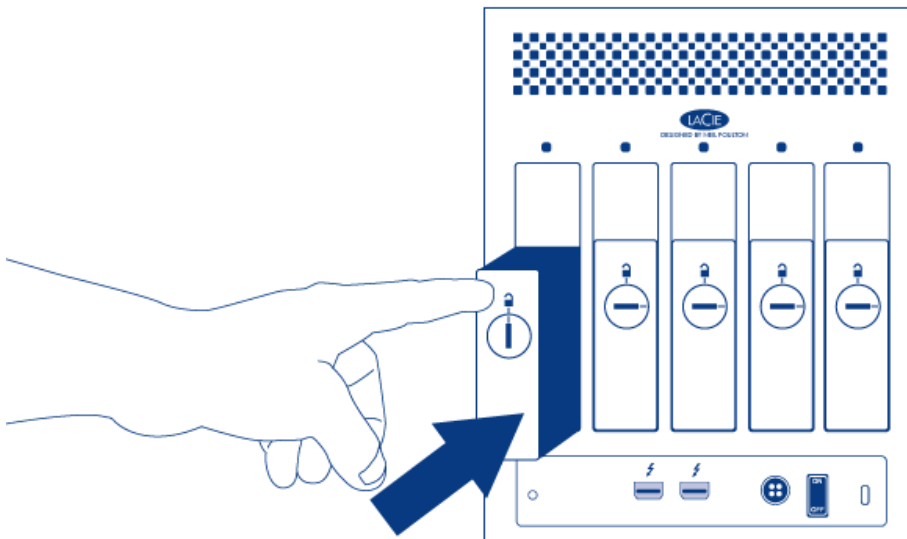

8. Use the disk lock tool to lock the disk(s) in place.

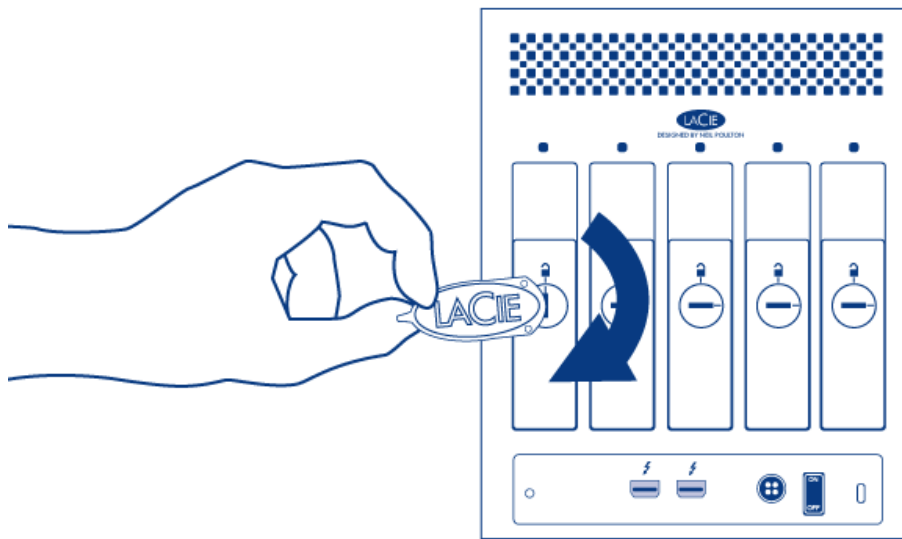

9. Turn on the product. Before the disk will mount on your desktop, it needs to be formatted into an HFS+ volume using Disk Utility. Then it can be integrated into a new RAID array as described in [Create a RAID Array](#). If you are replacing a disk that was in a RAID 1 array, refer to [this article](#) from Apple for instructions.

Caution: To avoid potential problems caused by electrostatic discharge (ESD), it is recommended that you do not touch the hard disk's printed circuit board. As a further precaution against ESD, use an anti-static wristband or an anti-static mat to ground yourself when handling the hard disk.

GETTING HELP

If you are having problems with your LaCie product, consult the table below for a list of available resources.

Order	Source	Description	Location
1	Quick Install Guide	Concise steps to follow for getting your product up and running	Either a printed leaflet or accessory box and included in the product box, or download PDF from the product page
2	Support Pages	Includes interactive troubleshooting topics for most common problems	www.lacie.com/support/ , select your product, then click the "Troubleshooting" tab
3	User Manual	Includes common troubleshooting topics	See Troubleshooting Topics below
4	Customer Support	Create an account on lacie.com , register your product, and fill out a support ticket	Create an account here: www.lacie.com/us/mystuff/login.htm?logout&rtm=mystuff

Note: LaCie is dedicated to providing high quality products that enrich the lives of our customers. To help LaCie offer the best customer support, we encourage you to create an account and register your product at www.lacie.com/us/mystuff/login.htm?logout&rtm=mystuff. You can give us important feedback as well as receive updated information on your LaCie device.

TROUBLESHOOTING TOPICS

Note: Interactive troubleshooting, a highly effective way to resolve problems with your product, is available from www.lacie.com/support/. Select your product, then click the “Troubleshooting” tab.

Problem: The front LED is solid red.

Fan malfunction. Log in to LaCie [technical support](#) and create a support ticket for warranty service.

Problem: One or more of the rear disk LEDs isn't on.

Is a compatible disk installed in the disk tray corresponding to that LED?

The LED turns on only if a compatible disk has been installed. For compatibility information, refer to [Install Disks](#).

Does the installed compatible disk fail to mount on your desktop?

This could indicate disk failure. If the disk was purchased from LaCie, log in to LaCie [technical support](#) and create a support ticket for warranty service.

Problem: I'm receiving file transfer error messages and/or Time Machine does not work.

Did you get an "Error -50" message while copying to the storage?

When copying files or folders from a computer to a FAT 32 volume, certain characters cannot be copied. These characters include, but are not limited to:

? < > / \ :

Since it does not offer optimal performance, LaCie does not recommend using the FAT 32 file system with your product. Additionally, Time Machine is only compatible with disks formatted in HFS+ or HFS+ (Journaled). Reformat the drive for Time Machine compatibility.

Problem: I got an error message telling me that the drive has been disconnected.

Did it happen when the computer was coming out of sleep mode?

Simply ignore this message. The drive will remount to the desktop. LaCie drives conserve power by spinning down when you set your computer to sleep mode, and when the computer is awoken from sleep, it may not give

the drive enough time to spin-up from its sleep mode.

Problem: The displayed available capacity doesn't seem right.

I just moved a lot of files into the trash from my product. Why isn't this reflected in the displayed available space?

Disk space will not be reclaimed until the file is completely erased. To remove the files forever, empty your trash.

Why is the volume capacity less than advertised on my storage?

After formatting, the available capacity of a drive will show less than advertised on the box. The difference is based upon how capacity is viewed by the operating system. For example, a hard drive that can store 500,000,000,000 bytes is divided by 1,000,000,000 to equal 500GB. This is the actual capacity listed on the manufacturer's box. The operating system uses slightly different math, dividing 500,000,000,000 by 1,073,741,824 to equal 466GB.

Problem: My product doesn't appear to be mounting on my computer.

Are there other Thunderbolt technology devices connected to the same port?

Disconnect any other Thunderbolt devices and see if the Thunderbolt Series volume appears on the desktop.

Does the icon/Do the icons for the Thunderbolt Series volume(s) appear on the desktop?

The drive icon(s) for the Thunderbolt Series storage should appear on your desktop, as long as the disks are compatible, are installed correctly, and have been formatted in HFS+ for use with a Mac computer. Please also confirm that the Finder preference for displaying external disks on the desktop is selected at **Finder > Preferences > General**.

Is the Thunderbolt Series enclosure connected to a Mac that supports Thunderbolt technology?

The connection type for Thunderbolt technology on the Mac is the Mini DisplayPort. While earlier Macintosh computers include one or more Mini DisplayPorts, they are only used to connect one or more monitors. Please note that legacy Mac computers with Mini DisplayPorts do not support Thunderbolt technology peripherals such as the LaCie Thunderbolt Series storage.

Did you follow the correct installation steps?

A:

- Review the installation steps ([Get Connected](#)).
- Make sure that the power supply is connected to a functioning power outlet or power strip, and that the power button on the LaCie 5big and the power strip (if applicable) is turned on.
- Check both ends of the Thunderbolt cable to make sure they are fully seated in their respective ports.
- Try disconnecting the cable then wait 10 seconds before reconnecting it.
- If the product is still not recognized, restart your computer and try again.

I connected the Thunderbolt Series enclosure to my new Mac with an older Mini DisplayPort cable that I use for my monitors. Why can't I see the Thunderbolt Series volume(s) on the desktop?

The Thunderbolt Series storage requires cables specifically constructed for Thunderbolt technology. Go to www.lacie.com for more information on cables that support Thunderbolt technology.

I connected a cable that supports Thunderbolt technology to my new Mac but the Thunderbolt Series enclosure does: (a.) not power on and/or (b.) not receive sufficient power.

The Thunderbolt Series enclosure is not bus-powered through the Thunderbolt cable. You must connect the included power supply. See [Get Connected](#).

Problem: My LaCie 5big had a disk failure.

Was it configured in a RAID 1 array?

If your RAID array was protected, the disk failure did not result in data loss. Follow these steps:

1. Purchase a [LaCie 5big Spare Drive](#) or a [new disk from LaCie](#) or a [compatible third-party disk](#).
 2. Install the disk. Refer to [Install Disks](#) for details.
 3. Rebuild the RAID array. Refer to this [article](#) from Apple for instructions.
-

Was it configured in a RAID 0 or JBOD array?

If your RAID array was not protected, the disk failure resulted in data loss. Replace the disk as described in [Install Disks](#).

LEGAL INFORMATION

COPYRIGHTS

Copyright © 2015 LaCie. All rights reserved. No part of this publication may be reproduced, stored in a retrieval system, or transmitted in any form or by any means, electronic, mechanical, photocopying, recording or otherwise, without the prior written consent of LaCie.

CHANGES

The material in this document is for information only and subject to change without notice. While reasonable efforts have been made in the preparation of this document to assure its accuracy, LaCie assumes no liability resulting from errors or omissions in this document, or from the use of the information contained herein. LaCie reserves the right to make changes or revisions in the product design or the product manual without reservation and without obligation to notify any person of such revisions and changes.

FEDERAL COMMUNICATION COMMISSION INTERFERENCE STATEMENT

This equipment has been tested and found to comply with the limits for a Class B digital device, pursuant to Part 15 of the FCC Rules. These limits are designed to provide reasonable protection against harmful interference in a residential installation. This equipment generates, uses and can radiate radio frequency energy and, if not installed and used in accordance with the instructions, may cause harmful interference to radio communications. However, there is no guarantee that interference will not occur in a particular installation. If this equipment does cause harmful interference to radio or television reception, which can be determined by turning the equipment off and on, the user is encouraged to try to correct the interference by one of the following measures:

1. Reorient or relocate the receiving antenna.
2. Increase the separation between the equipment and receiver.
3. Connect the equipment into an outlet on a circuit different from that to which the receiver is connected.
4. Consult the dealer or an experienced radio/TV technician for help.

FCC Caution: Any changes or modifications not expressly approved by the party responsible for compliance could void the user's authority to operate this equipment.

This device complies with Part 15 of the FCC Rules. Operation is subject to the following two conditions: (1) This device may not cause harmful interference, and (2) this device must accept any interference received, including interference that may cause undesired operation.

Important info: FCC Radiation Exposure Statement: This equipment complies with FCC radiation exposure limits set forth for an uncontrolled environment. This equipment should be installed and operated with minimum distance 20 cm between the radiator & your body.

This transmitter must not be co-located or operating in conjunction with any other antenna or transmitter. The availability of some specific channels and/or operational frequency bands are country dependent and are

firmware programmed at the factory to match the intended destination. The firmware setting is not accessible by the end user.

WEEE



This symbol on the product or on its packaging indicates that this product must not be disposed of with your other household waste. Instead, it is your responsibility to dispose of your waste equipment by handing it over to a designed collection point for the recycling of waste electrical and electronic equipment. The separate collection and recycling of your waste equipment at the time of disposal will help to conserve natural resources and ensure that it is recycled in a manner that protects human health and the environment. For more information about where you can drop off your waste equipment for recycling, please contact your local city office, your household waste disposal service, or the shop where you purchased the product.

MANUFACTURER'S DECLARATION FOR CE CERTIFICATION



We, LaCie, solemnly declare that this product conforms to the following European standards: Electromagnetic Compatibility Directive (2004/108/EC); Low-Voltage Directive: 2006/95/EC

TRADEMARKS

Apple, Mac, Time Machine, and Macintosh are registered trademarks of Apple Computer, Inc. Microsoft, Windows XP, Windows Vista, and Windows 7 are registered trademarks of Microsoft Corporation. Other trademarks mentioned in this manual are the property of their respective owners.

CANADA COMPLIANCE STATEMENT

This Class B digital apparatus meets all requirements of the Canadian Interference-Causing Equipment Regulations.

CAN ICES-3 (B)/NMB-3(B)

JAPAN COMPLIANCE STATEMENT

This is a Class B product based on the standard of the Voluntary Control Council for Interference from Information Technology Equipment (VCCI). If this is used near a radio/TV receiver, it may cause radio interference. Install the equipment according to the manual. This statement does not apply to the LaCie CloudBox.

PRECAUTIONS

Caution: It is essential that you use only the power supply that shipped with your product, since it is a shielded-type power cord that meets FCC emission limits as well as to prevent interference to the nearby radio and television reception.

Caution: Modifications not authorized by the manufacturer may void the user's authority to operate this device.

Important info: Any loss, corruption or destruction of data while using a LaCie drive is the sole responsibility of the user, and under no circumstances will LaCie be held liable for the recovery or restoration of this data. To help prevent the loss of your data, LaCie highly recommends that you keep TWO copies of your data; one copy on your external hard disk, for instance, and a second copy either on your internal hard disk, another external hard disk or some other form of removable storage media. If you would like more information on backup, please refer to our website.

Important info: 1TB (Terabyte) = 1,000GB. 1GB = 1000MB. 1MB = 1,000,000 Bytes. Total accessible capacity varies depending upon operating environment (typically up to 10% less per TB).

HEALTH AND SAFETY PRECAUTIONS

- Only qualified persons are authorized to carry out maintenance on this device.
- Read this User Manual carefully and follow the correct procedure when setting up the device.
- Do not open a disk drive or attempt to disassemble or modify it. Never insert any metallic object into the drive to avoid any risk of electrical shock, fire, short-circuiting or dangerous emissions. The disk drives shipped with your LaCie device contain no user-serviceable parts. If it appears to be malfunctioning, have it inspected by a qualified LaCie Technical Support representative.
- Never expose your device to rain, or use it near water, or in damp or wet conditions. Never place objects containing liquids on the LaCie device, as they may spill into its openings. Doing so increases the risk of electrical shock, short-circuiting, fire or personal injury.
- Make sure that the computer and LaCie device are electrically grounded. If the devices are not grounded, there is an increased risk of electrical shock.

GENERAL USE PRECAUTIONS

- Power requirements 100-240 V~, 50-60 Hz, (supply voltage fluctuations not exceeding $\pm 10\%$ of the nominal and transient over-voltages according to over-voltage category II).
- Do not expose the LaCie device to temperatures outside the range of 5° C to 30° C (41° F to 86° F); or to operational humidity beyond 10-80%, non-condensing, or non-operating humidity beyond 10-90%, non-condensing. Doing so may damage the LaCie device or disfigure its casing. Avoid placing your LaCie device near a source of heat or exposing it to sunlight (even through a window). Inversely, placing your LaCie device in an environment that is too cold may damage the unit.
- Rated cooling for altitudes up to 2000 meters.
- If your drive features a power cable, always unplug it from the electrical outlet if there is a risk of lightning or if it will be unused for an extended period of time. Otherwise, there is an increased risk of electrical shock, short-circuiting or fire.
- Use only the power supply shipped with the device (if applicable).
- Do not use the LaCie device near other electrical appliances such as televisions, radios or speakers. Doing so may cause interference which will adversely affect the operation of the other products.
- Do not place the LaCie device near sources of magnetic interference, such as computer displays, televisions or speakers. Magnetic interference can affect the operation and stability of your LaCie device.
- Never use excessive force on your LaCie device. If you detect a problem, consult the troubleshooting section in this manual.
- Protect your LaCie device from excessive exposure to dust during use or storage. Dust can build up inside the device, increasing the risk of damage or malfunction.
- Never use benzene, paint thinners, detergent or other chemical products to clean the outside of the LaCie device. Such products will disfigure and discolor the casing. Instead, use a soft, dry cloth to wipe the device.

WARRANTY INFORMATION

LaCie offers first-rate service and support through our generous three-tiered warranty policy. Our 1-, 2-, 3-, and 5-year policies include comprehensive, complimentary web-based resources, expert in-house technical support, and worldwide repair and/or replacement coverage. To benefit from this warranty, please contact LaCie Support at www.lacie.com/us/support where you can find online support and contact information. You may also contact representatives at the original point of purchase who will be able to help guide you.

Standard warranties vary depending on the product. To verify your product's warranty status and to see which standard warranty is included with your product, type in your product's serial number at www.lacie.com/us/support. If no warranty is listed under your product's name, this means that the warranty has expired.

WARRANTY UPGRADES

If you wish to extend your warranty coverage, you can purchase Silver, Gold, or Platinum Care or Advanced Exchange. For details, see www.lacie.com/warranties.

LEGAL INFORMATION

A standard LaCie limited warranty is included with all products. Please read the terms and conditions below.

LaCie Limited Warranty Policy

LaCie ("LaCie") warrants, to the original purchaser, that this equipment shall be free of defects in materials and workmanship for a period of one (1), two (2), three (3), or five (5) years, depending on the model, from LaCie's date of original shipment when the equipment is used normally and is properly serviced when needed. If you discover a defect covered by the warranty set forth above, your sole and exclusive remedy will be for LaCie, in its sole discretion to (i) repair or replace the product at no charge to you; or, if a repaired unit or replacement product is not available, (ii) to refund the current market value of your product. You acknowledge and agree that replacement product, at the sole option of LaCie, may be a new product or a remanufactured product. In order to receive the remedy set forth above, you must return the product during the warranty period and include with each returned product (i) a copy of your original purchase invoice to verify your warranty; (ii) a Return Material Authorization number; (iii) your name, address and telephone number; (iv) a copy of the bill of sale bearing the appropriate LaCie serial numbers as proof of date of original retail purchase; and (v) a description of the problem. The customer must pay all transportation costs for a returned product. The product will need to be returned to LaCie within the country of original retail purchase. This warranty applies only to hardware products; LaCie software, media, and manuals are licensed and warranted pursuant to separate written agreement. This warranty does not apply if the product has been misused or has been damaged by accident, abuse, misuse, or misapplication; if it has been modified without permission of LaCie; or if any LaCie serial number has been removed or defaced. If a customer has purchased a LaCie Advance Care Option (ACO) to go with this equipment, the ACO shall be valid for three (3) years from activation.

EXCEPT FOR THE LIMITED WARRANTY SET FORTH ABOVE, ALL PRODUCTS ARE SOLD “AS IS” AND LACIE EXPRESSLY DISCLAIMS ALL WARRANTIES OF ANY KIND, WHETHER EXPRESS, IMPLIED OR STATUTORY, INCLUDING THE IMPLIED WARRANTIES OF MERCHANTABILITY, NONINFRINGEMENT AND FITNESS FOR A PARTICULAR PURPOSE. WITHOUT FURTHER LIMITING THE GENERALITY OF THE FOREGOING, DOES NOT WARRANT (1) THE PERFORMANCE OR RESULTS OBTAINED FROM USING THIS PRODUCT, (2) THAT THE PRODUCT IS APPROPRIATE FOR THE CUSTOMER'S PURPOSES, (3) THE MANUAL IS ERROR FREE, OR (4) THAT NO DATA WILL BE LOST WHILE USING THE PRODUCT. THE ENTIRE RISK AS TO THE RESULTS AND PERFORMANCE IS ASSUMED BY THE CUSTOMER. THE WARRANTY AND REMEDIES SET FORTH ABOVE ARE EXCLUSIVE AND IN LIEU OF ALL OTHERS, ORAL OR WRITTEN, EXPRESS OR IMPLIED.

EXCLUSIONS AND LIMITATIONS

This Limited Warranty applies only to hardware products manufactured by or for LaCie that can be identified by the “LaCie” trademark, trade name, or logo affixed to them. The Limited Warranty does not apply to any non-LaCie hardware products or any software, even if packaged or sold with LaCie hardware. Manufacturers, suppliers, or publishers, other than LaCie, may provide their own warranties to the end user purchaser, but LaCie, in so far as permitted by law, provides their products “as is”. Software distributed by LaCie with or without the LaCie brand name (including, but not limited to system software) is not covered under this Limited Warranty. Refer to the licensing agreement accompanying the software for details of your rights with respect to its use.

LaCie does not warrant that the operation of the product will be uninterrupted or error-free. LaCie is not responsible for damage arising from failure to follow instructions relating to the product's use. This warranty does not apply: (a) to consumable parts, unless damage has occurred due to a defect in materials or workmanship; (b) to cosmetic damage, including but not limited to scratches, dents and broken plastic on ports; © to damage caused by use with non-LaCie products; (d) to damage caused by accident, abuse, misuse, flood, fire, earthquake or other external causes; (e) to damage caused by operating the product outside the permitted or intended uses described by LaCie; (f) to damage caused by service (including upgrades and expansions) performed by anyone who is not a representative of LaCie or a LaCie Authorized Service Provider; (g) to a product or part that has been modified to alter functionality or capability without the written permission of LaCie; or (h) if any LaCie serial number on the product has been removed or defaced.

No LaCie dealer, agent, or employee is authorized to make any modification, extension, or addition to this warranty.

Any loss, corruption or destruction of data while using a LaCie drive is the sole responsibility of the user, and under no circumstances will LaCie be held liable for the recovery or restoration of this data. To help prevent the loss of your data, LaCie highly recommends that you keep TWO copies of your data; one copy on your external hard disk, for instance, and a second copy either on your internal hard disk, another external hard disk or some other form of removable storage media. LaCie offers a complete line of CD and DVD drives. If you would like more information on backup, please refer to our website.

LACIE IS NOT RESPONSIBLE FOR SPECIAL, INCIDENTAL, OR CONSEQUENTIAL DAMAGES RESULTING FROM ANY BREACH OF WARRANTY, OR UNDER ANY LEGAL THEORY, INCLUDING LOST PROFITS, DOWNTIME, GOODWILL, DAMAGE TO OR REPLACEMENT OF EQUIPMENT AND PROPERTY, AND ANY COSTS OF RECOVERING, REPROGRAMMING, OR REPRODUCING ANY PROGRAM OR DATA STORED IN OR USED WITH LACIE PRODUCTS EVEN IF IT HAS BEEN ADVISED OF THE POSSIBILITY OF SUCH DAMAGES.

Some states do not allow the exclusion or limitation of implied warranties or liability for incidental or consequential damages, so the above limitation or exclusion may not apply to you. This warranty gives you specific legal rights, and you may have other rights, which vary from state to state.

Your opening of your package, your use of the product, or your return of the enclosed Registration Card acknowledges that you have read and agree to the terms of this Agreement. You further agree that it is the complete and exclusive state of the agreement between us and supersedes any proposal or prior agreement, oral or written, and any other communications between us relating to the subject matter of this Agreement.

Read carefully all information related to warranty and precautions of use of your new LaCie product in the user manual.

For products purchased in the United States, you may contact LaCie at 7555 Tech Center Drive, Tigard, Oregon 97223 USA. Email: sales@lacie.com. Website: www.lacie.com. Customer service: 503-844-4503.

Service DOA

On rare occasions, a newly purchased LaCie product may be delivered in non-working order. We are working to avoid these issues, but unfortunately, these situations may arise from time to time. Within the 15 calendar days of purchase, should you experience an issue with your new LaCie product, we ask you to return the product to the place where it was originally bought. You will be required to give a proof of purchase.

Customer Warning

Please be sure to back up your data before returning your drive to LaCie for repair. LaCie cannot under any circumstances guarantee the integrity of data remaining on a returned drive. We make no provisions for data recovery and cannot be held liable for any data loss on drives or media returned to LaCie.

All products returned to LaCie must be securely packaged in their original box and shipped with postage prepaid, except for Products registered under the Advance Care Option.

NOTE TO AUSTRALIAN CUSTOMERS

Our goods come with guarantees that cannot be excluded under the Australian Consumer Law. You are entitled to a replacement or refund for a major failure and for compensation for any other reasonably foreseeable loss or damage. You are also entitled to have the goods repaired or replaced if the goods fail to be of acceptable quality and the failure does not amount to a major failure.

Contact us:

LaCie Australia, 6/151 Beauchamp Rd, Matraville NSW 2036 AUSTRALIA

Phone: 02 8063 3711

Email: info.au@lacie.com

For fast technical support, create a support ticket after registering your product at www.lacie.com/au/register.